

Air Force Institute of Technology

AFIT Scholar

---

Theses and Dissertations

Student Graduate Works

---

3-2020

## Inherent Jeopardy of Performance Based Contracting Metrics: A Simulation Experiment

Daniel Cherobini

Follow this and additional works at: <https://scholar.afit.edu/etd>



Part of the [Management and Operations Commons](#), and the [Operations and Supply Chain Management Commons](#)

---

### Recommended Citation

Cherobini, Daniel, "Inherent Jeopardy of Performance Based Contracting Metrics: A Simulation Experiment" (2020). *Theses and Dissertations*. 3894.  
<https://scholar.afit.edu/etd/3894>

This Thesis is brought to you for free and open access by the Student Graduate Works at AFIT Scholar. It has been accepted for inclusion in Theses and Dissertations by an authorized administrator of AFIT Scholar. For more information, please contact [richard.mansfield@afit.edu](mailto:richard.mansfield@afit.edu).



**INHERENT JEOPARDY OF PERFORMANCE BASED CONTRACTING  
METRICS: A SIMULATION EXPERIMENT**

THESIS

Daniel Cherobini, Captain, Brazilian Air Force

AFIT-ENS-MS-20-M-139

**DEPARTMENT OF THE AIR FORCE  
AIR UNIVERSITY**

**AIR FORCE INSTITUTE OF TECHNOLOGY**

**Wright-Patterson Air Force Base, Ohio**

DISTRIBUTION STATEMENT A. APPROVED FOR PUBLIC RELEASE;  
DISTRIBUTION UNLIMITED.

The views expressed in this thesis are those of the author and do not reflect the official policy or position of the United States Air Force, Department of Defense, or the United States Government, the corresponding agencies of any other government, or any other defense organization.

AFIT-ENS-MS-20-M-139

INHERENT JEOPARDY OF PERFORMANCE BASED CONTRACTING  
METRICS: A SIMULATION EXPERIMENT

THESIS

Presented to the Faculty

Department of Operational Sciences

Graduate School of Engineering and Management

Air Force Institute of Technology

Air University

Air Education and Training Command

In Partial Fulfillment of the Requirements for the  
Degree of Master of Science in Logistics and Supply Chain Management

Daniel Cherobini, B.E.

Captain, Brazilian Air Force

March 2020

DISTRIBUTION STATEMENT A. APPROVED FOR PUBLIC RELEASE;  
DISTRIBUTION UNLIMITED.

AFIT-ENS-MS-20-M-139

INHERENT JEOPARDY OF PERFORMANCE BASED CONTRACTING  
METRICS: A SIMULATION EXPERIMENT

Daniel Cherobini, B.E.  
Captain, Brazilian Air Force

Committee Membership:

Seong-Jong Joo, Ph.D.  
Chair

William A. Cunningham, Ph.D.  
Member

## Abstract

There is a growing trend across the world to adopt Performance Based Contracting strategies to support logistics systems. Using these policies, contract payments are strongly related to the performance achieved compared to prespecified metrics. However, managers are not always confident on what are the most suitable performance goals to use in these agreements. As a consequence, contractors struggle to deliver the desired performance results, while aircraft fleets experience an increase in support costs. In addition, when the results are inadequate, leaders are tempted to impose even stricter performance targets to contractors, willing to exercise more control over the support organization.

In this research, simulation is used to provide the quantitative evidence of how sensitive life support costs are to adding metrics to a Performance Based Contract, with a focus on changes in turnaround times and repair costs, for different logistical configurations. The study acknowledges the potential risk of adding intermediate metrics to these contracts, which possibly will only raise life support costs without a positive effect on the main objectives of a fleet: mission readiness or simply availability. Ultimate negative effects on contractors are also discussed and recommendations are provided to managers on how they could design more successful performance-based contracts.

*This thesis is dedicated to my beloved mother  
who have always been a source of inspiration,  
encouragement and stamina to undertake my studies  
and believe in myself, never giving up.*

*I also devote this work to some of my true friends,  
who made this moment possible when I imagined all was lost  
even before I had the chance to start it.*

*And last but not least, I offer my best praise to my wife,  
for granting me all the love and support I could have,  
even in the most difficult times, and also to my little kids,  
who certainly missed their daddy for a few moments,  
but were always there smiling, giving me tons of love  
and making it all worthwhile.*

*I love you all so much!  
Amo muito todos vocês!*

## Acknowledgments

I am very grateful to my faculty advisor, Dr. Seong-Jong Joo, for his patience and guidance over the past few months. His wisdom was fundamental for the study to proceed at a natural pace, encouraging me to explore the paths that led me to this research. My gratitude also goes to Dr. William A. Cunningham, who has accepted the responsibility of being the reader of this thesis, leaving me honored with his willingness. In addition, I would also like to register my deepest appreciation to all the other faculty members who taught my class. Your lessons were valuable and enabled in your students the critical and forward thinking, making us much improved managers and analysts.

I also need to thank the Brazilian Air Force, for giving me this great opportunity to develop and expand my capabilities as a logistics professional. In particular, a special mention to Col Paulo Sanches and Maj Jardel da Silva, who believed that I was the right person to face this challenge, giving me all the support I could have. And it would not be fair to forget to mention all the other fellow airmen like Maj Nelson Hotta who, even behind the curtains, helped me to overcome the greatest administrative hurdles I met a few days before embarking towards this great country in which I was able to complete my master's degree. I owe them my deep respect and gratitude.

Finally, to my logistics management cohort: you are the best! The cultural exchange was amazing, as we could learn so much from our Saudi friends, Abdul, Ayman, Nasser and Sami. And my American friends, Adam, Corbin, Christina, Kyle, Mike and Tom: you have a place in my heart. Thank you for making this journey incredible and meaningful with your kindness and respect. You are all more than welcome to come to Brazil any day, so that I can have the chance to make you feel at home, just as your reception here made me feel. I truly believe we all will keep great memories and knowledge from these 19 months we spent together, and use this to enhance our countries and also become better professionals and leaders.



## Table of Contents

	Page
Abstract.....	iv
Acknowledgments.....	vi
List of Figures.....	ix
List of Tables.....	xi
I. Introduction.....	1
Background.....	1
Problem Statement.....	3
Research Questions.....	4
Methodology.....	4
Scope.....	5
Assumptions and Limitations.....	5
Significance of Research.....	6
II. Literature Review.....	7
Performance Based Logistics.....	7
Drivers of PBL.....	8
Total Cost of Ownership.....	8
Life Cycle Costing.....	9
Performance Based Contracting.....	11
Best Practices.....	12
Incentive and Penalty Mechanisms.....	14
Determination of Good Metrics.....	15
III. Methodology.....	17
Simulation as a logistics tool.....	17
OPUS10 Software.....	18
Data Used as Input.....	19
Scenarios to be simulated.....	21
Basic Logistics Scenario (BLS).....	23
Alternative Logistics Scenario 01 (ALS1).....	24
Alternative Logistics Scenario 02 (ALS2).....	25
Alternative Logistics Scenario 03 (ALS3).....	26

Alternative Logistics Scenario 04 (ALS4).....	27
Changes on Repair Times and Costs induced by PBC Metrics in Each Scenario.....	28
Model Assumptions and Limitations.....	30
Experiments Simulated.....	31
IV. Results and Analysis.....	35
Comparative Results within Each Scenario.....	35
BLS Results .....	37
ALS1 Results .....	39
ALS2 Results .....	41
ALS3 Results .....	43
ALS4 Results .....	45
Analysis of the Results within Each Scenario .....	47
Comparative Results among Different Scenarios.....	50
Analysis of Research/Investigative Questions.....	54
RQ: How sensitive are the Life Support Costs to the addition of metrics in a Performance Based Contract?.....	54
IQ1: How does imposing a metric on the maximum turn-around time to repair a component affect LSC?.....	54
IQ2: Are these possible effects more sensitive in specific logistic configurations?..	55
Expanding the Interpretation for Different Changes in Logistics Configuration .....	55
V. Conclusions and Recommendations .....	58
Summary of the Research and Answers to Research Questions .....	58
Significance of Research .....	59
Recommendations for Actions.....	59
Recommendations for Future Research.....	60
Conclusions of Research.....	61
Bibliography .....	63

## List of Figures

Figure	Page
Figure 1. USAF Mission Capable Rates 2014-2017 - Adapted from Losey (2018).....	2
Figure 2. USAF Budget FY 2013-2020 - Adapted from Air Force Magazine (2019) .....	2
Figure 3. Life Cycle Costing formulation (Woodward, 1997) .....	10
Figure 4. OPUS10 Input Table: Materiel/ItemStructure – Quantities of items per system .....	20
Figure 5. OPUS10 Input Table: Materiel/Item – Unit prices and failure rates per item...	21
Figure 6. Positioning and transportation times for the first scenario (BLS).....	23
Figure 7. OPUS10 station structure for the first scenario (BLS) - both transportation times between stations (to send and return components) are considered the same .....	23
Figure 8. Positioning and transportation times for the second scenario (ALS1).....	24
Figure 9. OPUS10 station structure for the second scenario (ALS1) - both transportation times between stations (to send and return components) are considered the same .....	24
Figure 10. Positioning and transportation times for the third scenario (ALS2).....	25
Figure 11. OPUS10 station structure for the third scenario (ALS2) - both transportation times between stations (to send and return components) are considered the same .....	25
Figure 12. Positioning and transportation times for the fourth scenario (ALS3) .....	26
Figure 13. OPUS10 station structure for the fourth scenario (ALS3) - both transportation times between stations (to send and return components) are considered the same .....	26
Figure 14. Positioning and transportation times for the fifth scenario (ALS4) .....	27
Figure 15. OPUS10 station structure for the fifth scenario (ALS4) - both transportation times between stations (to send and return components) are considered the same .....	27
Figure 16. Cost/Effectiveness (C/E) curve given as output by OPUS10 (Systecon, n.d.)	32
Figure 17. Change of problem type to ANALYSIS in OPUS10 to evaluate life support costs and availability for a given assortment of items .....	33
Figure 18. OPUS10 output C/E curves and points for a 20% TAT reduction in BLS .....	37
Figure 19. Detailed view of the points of interest for a 20% TAT reduction in BLS.....	37
Figure 20. OPUS10 output C/E curves and points for a 40% TAT reduction in BLS .....	38

Figure 21. Detailed view of the points of interest for a 40% TAT reduction in BLS.....	38
Figure 22. OPUS10 output C/E curves and points for a 20% TAT reduction in ALS1 ...	39
Figure 23. Detailed view of the points of interest for a 20% TAT reduction in ALS1 ....	39
Figure 24. OPUS10 output C/E curves and points for a 40% TAT reduction in ALS1 ...	40
Figure 25. Detailed view of the points of interest for a 20% TAT reduction in ALS1 ....	40
Figure 26. OPUS10 output C/E curves and points for a 20% TAT reduction in ALS2 ...	41
Figure 27. Detailed view of the points of interest for a 20% TAT reduction in ALS2 ....	41
Figure 28. OPUS10 output C/E curves and points for a 40% TAT reduction in ALS2 ...	42
Figure 29. Detailed view of the points of interest for a 40% TAT reduction in ALS2 ....	42
Figure 30. OPUS10 output C/E curves and points for a 20% TAT reduction in ALS3 ...	43
Figure 31. Detailed view of the points of interest for a 20% TAT reduction in ALS3 ....	43
Figure 32. OPUS10 output C/E curves and points for a 40% TAT reduction in ALS3 ...	44
Figure 33. Detailed view of the points of interest for a 4% TAT reduction in ALS3 .....	44
Figure 34. OPUS10 output C/E curves and points for a 20% TAT reduction in ALS4 ...	45
Figure 35. Detailed view of the points of interest for a 20% TAT reduction in ALS4 ....	45
Figure 36. OPUS10 output C/E curves and points for a 40% TAT reduction in ALS4 ...	46
Figure 37. Detailed view of the points of interest for a 40% TAT reduction in ALS4 ....	46
Figure 38. BLS: Effect on LSC of different mixes of TAT and RC changes.....	48
Figure 39. ALS1: Effect on LSC of different mixes of TAT and RC changes.....	48
Figure 40. ALS2: Effect on LSC of different mixes of TAT and RC changes.....	48
Figure 41. ALS3: Effect on LSC of different mixes of TAT and RC changes.....	49
Figure 42. ALS4: Effect on LSC of different mixes of TAT and RC changes.....	49
Figure 43. Comparison between C/E curves for initial setups, in each logistics scenario	51
Figure 44. Comparison between tested logistics scenarios, given a 20% TAT reduction	53
Figure 45. Comparison between tested logistics scenarios, given a 40% TAT reduction	53

## List of Tables

Table	Page
Table 1: Drivers for PBL – Adapted from Berkowitz et al. (2003).....	8
Table 2: Measurement prescriptions for PBL agreements – Adapted from Doerr et al. (2004).....	13
Table 3: Logistics scenarios to be tested in OPUS10.....	22
Table 4: Specific groups for each component, when required.....	22
Table 5: Turnaround Times and Repair Costs in the initial condition and at 80% availability level.....	28
Table 6: Values to be tested due to TAT reductions and RC increases.....	30
Table 7: List of thirteen simulation runs to evaluate each logistics scenario.....	34
Table 8: Numerical results obtained in BLS for each simulation run in OPUS10.....	35
Table 9: Numerical results obtained in ALS1 for each simulation run in OPUS10.....	35
Table 10: Numerical results obtained in ALS2 for each simulation run in OPUS10.....	35
Table 11: Numerical results obtained in ALS3 for each simulation run in OPUS10.....	36
Table 12: Numerical results obtained in ALS4 for each simulation run in OPUS10.....	36
Table 13: Comparison among initial setup values with availability closer to 80%, in each scenario.....	51

## I. Introduction

### Background

Logistics support strategies have been shifted from transaction-based approaches, in which contractors are used to satisfy specific demands and receive pre-specified payments for their services, to Performance-Based Logistics (PBL), wherein a true partnership amongst customer and contractor must take place, which would bring benefits to both parties.

PBL has developed as a strategy for enhancing the performance and reducing the cost to sustain complex systems during the post production phase of their life-cycle, which often tops, by two or three times, the expenses verified in the development and production phases (Randall et al., 2010). While many papers use PBL as a synonym for Performance-Based Contracting (PBC), the latter technically refer to an instrument to achieve the former. PBC is a method of contracting designed to ensure that the essential levels of quality of performance are achieved and their payments are related to the degree to which the results meet the criteria of the contract (U.S. Department of Defense, 2016).

Across the world, there is a growing trend a to adopt Performance Based Contracting strategies to support logistics systems, so that contract payments are strongly related to the performance achieved compared to prespecified metrics. Nevertheless, managers are not always convinced on what are the most appropriate performance goals to use in such agreements. Consequently, contractors struggle to provide the required performance outcomes, whilst aircraft fleets may face an increase in support costs.

The current preferred product maintenance strategy to improve Department of Defense (DoD) weapon systems readiness is the PBL (Gardner et al., 2015). At the same time, there is evidence of decreasing performance in USAF mission-capable rates, as can be seen in Figure 1.

Aircraft	Active Inventory (2017)	2017	2016	Change	2015	2014
A-10	283	73.76%	74.09%	-0.33%	76.80%	75.10%
AC-130U	16	82.80%	81.18%	1.62%	83.40%	83.10%
B-1B	62	52.79%	51.62%	1.17%	47.00%	47.70%
B-2A	20	53.83%	51.11%	2.72%	55.90%	56.90%
B-52H	75	71.82%	73.92%	-2.10%	72.20%	73.50%
C-5M	48	60.25%	67.89%	-7.64%	69.00%	66.40%
C-17A	222	83.69%	85.12%	-1.43%	85.10%	85.60%
C-130H	188	73.14%	73.04%	0.10%	73.80%	72.70%
C-130J	110	76.96%	78.72%	-1.76%	79.80%	80.90%
CV-22B	50	66.61%	60.04%	6.57%	55.80%	59.30%
E-3B	11	69.19%	69.16%	0.03%	74.00%	76.50%
E-3C	3	67.39%	75.89%	-8.50%	78.70%	76.60%
E-3G	17	74.91%	79.28%	-4.37%	82.90%	83.40%
E-8C	16	63.88%	73.31%	-9.43%	76.40%	72.10%
F-15C	212	71.24%	71.22%	0.02%	70.70%	73.20%
F-15D	23	70.37%	59.89%	10.48%	64.20%	72.90%
F-15E	219	75.26%	72.94%	2.32%	71.30%	76.20%
F-16C	786	70.22%	73.06%	-2.86%	73.70%	74.40%
F-16D	155	65.96%	69.06%	-3.10%	70.70%	71.80%
F-22A	187	49.01%	60.18%	-11.17%	67.40%	72.70%
F-35A	119	54.67%	64.57%	-9.90%	67.90%	N/A
HH-60G	97	68.93%	67.28%	1.65%	76.90%	73.50%
KC-135R	344	73.19%	74.10%	-0.91%	75.40%	75.70%
KC-135T	54	75.25%	75.72%	-0.47%	76.10%	77.10%
MC-130H	17	68.53%	66.12%	2.41%	75.80%	69.60%
MC-130J	37	84.35%	86.72%	-2.37%	89.50%	88.30%
MD-1B	121	91.16%	91.63%	-0.47%	92.10%	91.30%
MO-9A	218	89.58%	88.48%	1.10%	88.40%	88.10%
MQ-4B	33	74.28%	78.10%	-3.82%	79.20%	82.90%
T-1A	178	55.94%	62.14%	-6.20%	67.30%	72.00%
T-4A	444	76.07%	66.71%	9.36%	60.90%	67.10%
T-38A	53	74.58%	80.96%	-6.38%	79.80%	81.60%
T-38C	443	59.74%	60.78%	-1.04%	62.70%	59.60%
U-2	27	75.20%	76.61%	-1.41%	78.50%	77.00%
UH-1N	63	83.57%	80.44%	3.13%	82.90%	83.20%
<b>Total (listed)</b>	<b>4960</b>					
<b>Total (entire fleet)</b>	<b>5349</b>					
<b>Average (entire fleet)</b>		<b>71.30%</b>	<b>72.10%</b>	<b>-0.80%</b>	<b>73.10%</b>	<b>73.70%</b>

### MISSION-CAPABLE RATES

Across the Air Force, roughly seven in 10 planes are ready to perform their designated missions at any given time. Mission-capable rates in fiscal 2017 ranged from 49 percent for the F-22A Raptor to 91.2 percent for the MQ-1B Predator unmanned aircraft. The chart shows the rates for some of the service's most well-known airframes, and how they compare to previous years' rates.

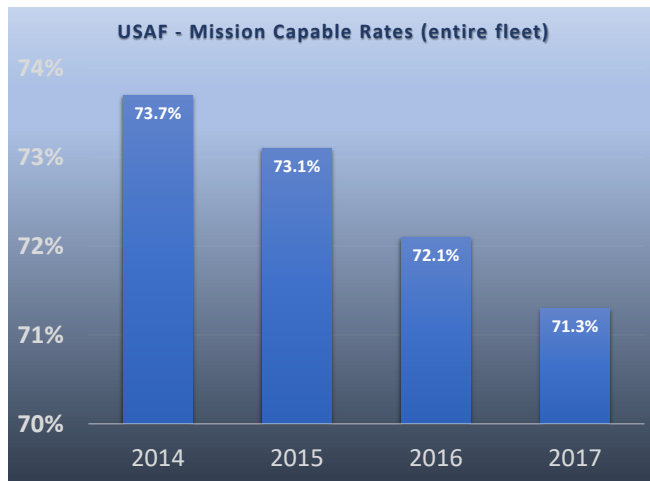

Figure 1. USAF Mission Capable Rates 2014-2017 - Adapted from Losey (2018)

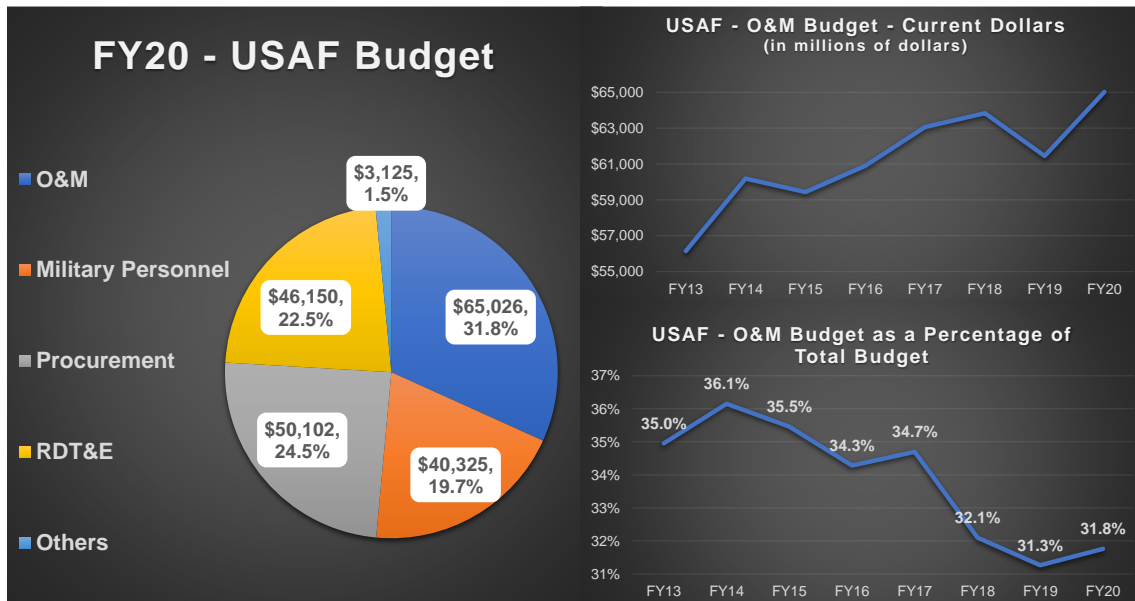

Figure 2. USAF Budget FY 2013-2020 - Adapted from Air Force Magazine (2019)

In addition, Figure 2 reveals that, in recent years, not only has the budget for Operations and Maintenance (O&M) grown in absolute numbers, but its share has also been reduced in relation to the total budget, indicating pressure for the use of an increasingly smaller slice of available resources in sustainment activities.

Faced with this challenging scenario, an opportunity arises to discuss possible reasons for these obstacles that are being encountered. Therefore, in this study potential issues regarding Performance-Based Contracting will be clarified, given the major role that this approach plays in the maintenance of these combat platforms.

### **Problem Statement**

In Performance-Based Contracting, results are driven by high-level goals discussed before the contract was established. But when the results provided by PBC are inadequate, logistics managers are tempted to enforce even more performance targets to contractors, eager to exercise more influence over the support structure.

Given the complexity inherent in the logistics chain of an aircraft fleet, it is impossible to have a clear idea of the effects of such potential changes, and considering the high-pressure environment and the permanent search for better and faster results, these consequences may be overlooked. Therefore, leaders need beforehand to have a general knowledge about the mechanisms related to this type of event, enabling more appropriate and well-founded decisions.

For this reason, the objective of this research is to provide evidence of how sensitive life support costs can be to adding metrics to a Performance-Based Contract, here focusing on changes in turnaround times and repair costs, for different logistical configurations. The study will acknowledge the potential risk of adding intermediate



metrics to these contracts, while also debating eventual negative effects on contractors. At last, recommendations will be provided to managers on how they could design more successful performance-based contracts.

### **Research Questions**

In order to achieve the proposed objectives of this research, the following research questions are offered:

*Research Question (RQ):* How sensitive are the Life Support Costs to the addition of metrics in a Performance Based Contract?

*Investigative Question 1 (IQ1):* How does imposing a metric on the maximum turn-around time to repair a component affect LSC?

*Investigative Question 2 (IQ2):* Are these possible effects more sensitive in specific logistic configurations?

### **Methodology**

Simulation will be used in this research to fulfill the objective of providing quantitative evidence of how sensitive life support costs are to adding metrics to a Performance-Based Contract, with a focus on changes in turnaround times and repair costs, for different logistical configurations.

The Swedish software OPUS10 was chosen as the tool for this purpose, considering its remarkable capabilities to model different support organizations and implement a wide range of logistical parameters, presenting as a main result something quite suitable for the objectives of this study: the cost/effectiveness curve, which will inform each of the configurations that will provide better availability results for a given life support cost.

## **Scope**

This study will only address some very specific logistics support structures, as will be discussed later, without using real data at any time. The goal here is to provide indications to substantiate a reasoning that can be applied in similar real-world cases, aiding to develop general concepts about the role metrics can play in Performance-Based Contracts.

## **Assumptions and Limitations**

The simulation model will assume different logistics scenarios with an initial setup where the support organization is working with optimal performance for an availability level of 80%, which would hardly represent the real world, given the very dynamic environment in which an aircraft fleet is inserted, thus, it is unlikely that a logistics system will be operating optimally.

Aircraft components will be the only items to fail in the model, but not the aircraft itself. Workshops (from contractors) will be the only sites allowed to repair them, so there will be no maintenance at the bases or depots, nor preventive or predictive inspections. The only station authorized to store components will be the depot, so nothing could be stocked on any base. Moreover, items will only be able to go up to the mother station - from base to depot, and from depot to workshop - and vice-versa. Consequently, there is no lateral support, nor cannibalization. Transportation times are considered fixed and the same for shipping and returning items between stations.

Two sources of expenditures will sum up to calculate the life support costs simulation model: repair costs, occurring when an item is fixed at a workshop after its failure; and the acquisition costs, to purchase the necessary quantity of components to be

allocated in each logistical configuration, which will guarantee the system's capacity to reach the desired availability levels. Therefore, any other type of cost will not be included in this analysis, such as storage costs, man-hours costs, depreciation costs, or transportation costs.

Finally, only certain values of changes in TAT and RC will be modeled. So, any other impact on the logistical configuration possibly caused by TAT reduction will not be considered, just the possible effect on repair costs. In actual situations, if the logistics system is operating with faster turnaround times, the depot will need to store fewer components, reducing storage cost, for example. However, these additional effects will not be taken into account in this study.

### **Significance of Research**

Academia has plenty of research addressing Performance-Based Contracting, but most of them intend to debate their possible benefits compared to conventional support approaches. In addition to the smaller number of studies that evaluate the practical challenges of PBC, quantitative studies in these areas are also lacking.

Thereby, this research will provide significant contribution helping to fill such gap, providing quantitative evidence about the intrinsic mechanisms associated with decisions on contract design, in order to offer measurable information to logistics leaders concerning the adjacent effects on life support costs that the unreasonable imposition of performance metrics can cause.

## II. Literature Review

### Performance Based Logistics

Performance Based Logistics (PBL) is currently the main strategy used by the U.S. Department of Defense (DoD) to enhance warfighter capability, reduce deployment footprint, and reduce the cost of ownership, presenting new opportunities and challenges (Coogan & Fellow, 2003). A more comprehensive definition from the DoD PBL Guidebook (2016) is provided below:

PBL is an outcome-based support strategy that delivers an integrated, affordable product support solution that satisfies warfighter requirements while reducing Operating and Support (O&S) costs. When dealing with industry, product support outcomes are acquired through performance-based arrangements that deliver warfighter requirements and incentivize product support providers to reduce costs through innovation.

Therefore, PBL is an instrument to combine acquisition and sustainment, applying the best business practices to achieve better performance, guarantee mission readiness and reduce costs. Data must be collected to ensure PBL attains the desired results, mainly regarding costs and desired performance.

However, managers responsible for adopting such approach must be cautious, because despite its possible benefits, noticeable risks are always involved. In the words of Davis et al. (2016): “A PBL arrangement buys an affordable outcome that effectively supports the warfighter requirements... if the agreement is structured correctly”.

## Drivers of PBL

Among the reasons why customers decide to adopt PBL agreements, Berkowitz et al. (2003) list seven different factors, as given in Table 1.

**Table 1: Drivers for PBL – Adapted from Berkowitz et al. (2003)**

1. Rising cost of maintenance, operations and support for new and legacy missile systems
2. Needed tool for Logistics Transformation and other actions required by Government
3. Needed reduction of customer wait time in support of the warfighter
4. Needed modernization of weapon systems to enhance combat capability
5. Needed solutions to weapon obsolescence problems
6. Documented savings from commercial logistics support operations
7. Documented improvements from implementation of performance-based acquisition

It is worth mentioning that, in fact, one of the main purposes for adopting this PBL strategy is that customers want to transfer the risk of output uncertainty to the service provider, in the form of contract payment uncertainty (Kim et al., 2010).

The adoption of a PBL approach is mainly governed by the intention of aligning customer and supplier objectives and incentives. Meeting these concerns together can be tricky, though, especially when trying to align partners' views on risk and reward distribution. A critical point is the relationship between the possible benefits of this strategy and its costs, considering the possible design of complicated and expensive measurement systems (Selviaridis & Norrman, 2015).

## Total Cost of Ownership

The adoption of a strategic purchasing focus has been stimulated by a series of recent trends that have focused on the quality of the purchase of materials and services, on the rationalization of the supply base and on stimulating competition. Increasingly,

decisions involving acquisitions affect a large part of a company's total costs, whether in terms of direct acquisition costs, but also in indirect costs, such as in the areas of inventory management, quality control, and administration in general. Total Cost of Ownership (TCO) is a tool to assess these indirect costs, establishing a more strategic focus on purchasing and supply management (Hurkens et al., 2006).

When managing the logistics chain with a focus on TOC, it is possible to carry out strategic planning that allows synergy between private suppliers and service providers to meet military demands (Glas et al., 2013). Using this methodology, the negotiation of performance standards is broader, aiming not only to reduce costs but also the improvement of logistics performance factors, such as cycle times, hours needed for maintenance work or even time between failures. In addition to reducing TOC through lower amount of labor and inventories, the support system can also become more robust in the face of eventual contingencies (Camm et al., 2004).

Therefore, complex logistical systems such as those related to military aircraft fleets must carry out their planning, not only by looking at individual cost entities, but using a TOC approach, which will allow the best global results to be obtained by making the sustainment structure more cost efficient.

### **Life Cycle Costing**

The tool commonly used to establish TCO is called the Life Cycle Costing, which consists of a process of identifying and documenting all costs involved over the life of an asset. LCC is the sum of all types of expenses in support of an item from its conception and manufacture, throughout its operation, until the end of its useful life (Woodward, 1997).

Expenses related to initial investments in a logistical support system correspond to only a small part of all operating costs that will be incurred during its life span. Thus, the life cycle technique is essential in Performance-Based Logistics, since, in general, an air force's fleets will operate for decades (Glas et al., 2013).

The decrease in the life cycle cost can occur through the conversion of transactional expenses year by year, from traditional maintenance, into large cost reduction pools, which should be used to encourage investment in technology, material and process that increases the reliability of the system, while maintaining its performance. In a traditional approach, the customer generally does not have a capital reserve in the current year to invest in reliability improvements, even though the life cycle cost could present marked reductions (Nowicki et al., 2010).

There are some differences between the categories used by each author to define the entire Life Cycle Cost. Figure 3 shows the formulation stated by Woodward (1997).

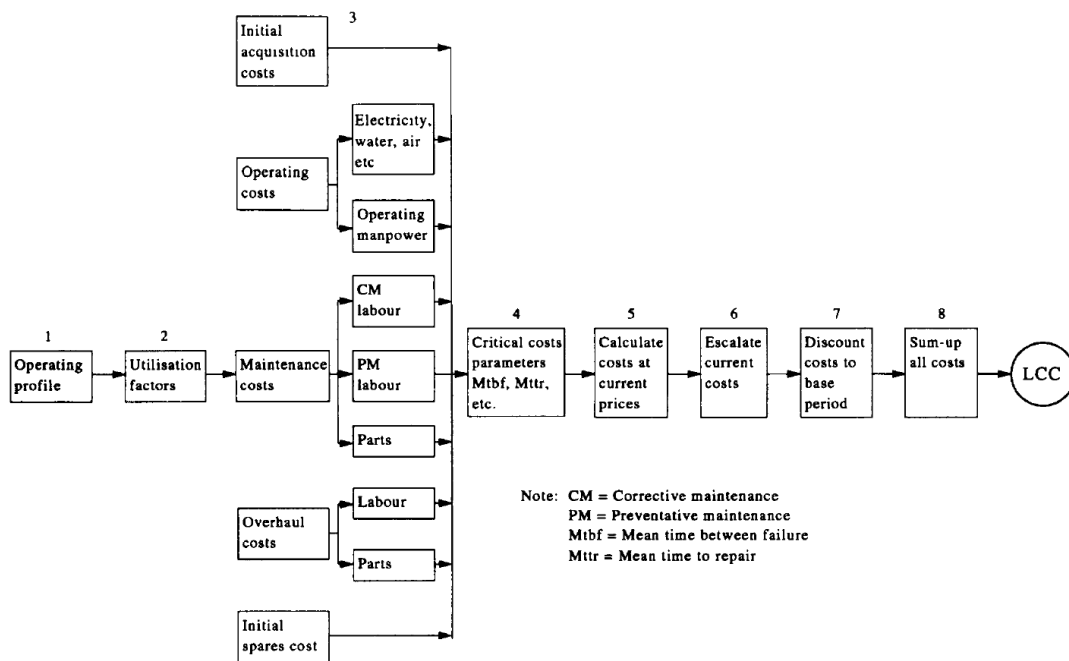

Figure 3. Life Cycle Costing formulation (Woodward, 1997)

In other work, Bengtsson & Kurdve (2016) divided the LCC between project costs, acquisition costs, life support costs, and life operations costs. OPUS10 commonly uses as an output the life support costs (LSC), given by the expected investment and operating cost associated with the support system design (Hallin, 2015).

### **Performance Based Contracting**

The literature uses a wide range of terms to refer to Performance-Based Logistics, sometimes Performance-Based Contracting (PBC) is used as a synonym of PBL. However, a more accurate and specific description is provided by (Hunter & Ellman, 2017):

Performance-based contracting is a type of contracting that calls for contracts to be structured in such a way as to enable and reward better performance on the part of the service provider or contractor.

In this type of contract, a specific focus is given to the specifications, no longer ruling the processes of how the service will be executed, but rather emphasizing the expected results for the service, whether in financial terms or any other type of positive resulting impact. At least part of the supplier's payment must be linked to the achievement of a given metric, making the supplier subject to greater financial risks related to performance (Selviaridis & Norrman, 2015).

Datta & Roy (2013) also discuss that in PBC the option is made not to acquire the possession of a product, but rather the result that it will bring. Therefore, compared to the traditional contracting process, PBC provides a better alignment between risks and incentives, and an adequate relationship between providers and customers is essential for the success of the contract. However, as the final requirement is for the result of the



service, it can be challenging to assess the quality of the service provided, associated with the difficulty of standardizing production due to the continuous involvement of the customer.

### **Best Practices**

To fully meet the objectives of PBC, an accurate evaluation of current performance in measurable terms must first be made, differentiating overall performance in terms of Operational Availability (or some other expression of readiness) and a measure of life support costs. These general performance metrics can be broken down into lower-level metrics, such as reliability and supply lead times, and a clear definition of the performance required by the final user is needed. Consequently, an appropriate business type must define how to move performance from where it is to where it is required by the warfighter, being able to evaluate a wide range of business options, determining the cost and risk associated with each option. These options may involve providing all support elements, such as maintenance supply support, training, in-service engineering and technical documentation management. Finally, once the desired solution is chosen and employed, the performance of the entire support range must be measured, making the necessary modifications to accomplish the performance goals (Coogan & Fellow, 2003).

A successful execution of a PBL agreement occurs through an iterative process, in which it is important to produce consistent reports, communicate regularly with major stakeholders and periodically review the performance of the contract. Some of the best practices related to managing these arrangements include: perform an opening meeting after contract award; ask for brief and informative contractor reports; quarterly review

meetings direct with contractor; flexibility with Governance processes as contract matures; understanding of PBL contract and contractor’s proposal; establishment of an internal PBL management team and a Governance plan with external stakeholders (U.S. DoD, 2016).

The literature indicates some key ideas regarding the impact of measurements in the potential success of a PBL arrangement. Table 2 presents a set of prescriptions for measurement that could be used to guide PBC design decisions:

**Table 2: Measurement prescriptions for PBL agreements – Adapted from Doerr et al. (2004)**

1	PBL should carry out less commercial sector participation if operational risk is high or difficult to measure.
2	The duration of the contract should be shorter when commercial sector providers undertake less (measurable) operational risk under contract.
3	Integrated weapon system models to support business case analysis should be used when a PBL contract cover less than comprehensive logistical support for a weapon system (e.g., for a component).
4	The metrics used for managing PBC should address valued outcomes and must be associated to the cost, readiness and agility of the weapons system. Process measures should be applied only when major operational decisions depend on the status of the process itself.
5	In ongoing PBL contracts, operational risk (variability) in key performance measures must be assessed, and variability reduction must be bolstered with proper incentives, when critical to mission support.

## **Incentive and Penalty Mechanisms**

Gardner et al. (2015) concluded that the DoD may balance PBL contracts to mitigate operational and financial risks, while simultaneously building long-term partnerships that encourage investment from commercial contractors, concentrating efforts in congressional funding methods (which are not compatible with PBL), using contract's option years to provide more flexibility (and maybe flexible performance), improving incentives with increased use of profit sharing, making long-term contracts, and also working towards fixed price/price-based contracts.

According to Datta & Roy (2013), contractor's decision to share the cost of uncertainty with the sub-suppliers helps to form the basis of sustainable success of performance-based outsourcing contracts.

There are three key findings in the research of Hunter & Ellman (2017) regarding incentives: contract length is the most powerful incentive; negative monetary incentives are effective, even down to the subcontractor level; positive monetary incentives are not seen as effective or desirable.

Talking about how to incentivize or penalize a contractor, Wååk & Sturgess (2000) postulate that the adoption of penalty clauses requires good judgement, as the contract can be harmed if possible sanctions could induce the contractor to go out of business, given that in certain cases he would be the only one to be able to perform some type of service. Unreasonable application of sanctions in these situations can lead to unsolvable conflicts. The authors further suggest that the adoption of incentives should be preferred, such as, for example, increasing a payment if repair turnaround times are consistently hit.

Another important aspect about sanctions in PBC is presented in the study by Girth (2014), which states that the mere existence of contractual mechanisms to penalize the service provider is not enough to hold them accountable in case of poor performance. Among the factors that act against the accountability of the contract, the author points out the amount of discretion managers select to use, the level of administrative burden related with the sanction procedure, and the degree to which the purchasing organization is reliant on the poor-performing contractor's expertise.

### **Determination of Good Metrics**

Defining a metric that translates warfighter objectives is a fundamental activity when choosing PBC. However, if such contracts are applied to specific subsystems or components, the metrics must be adjusted to reflect the correct level of responsibility delegated to the service provider, in order to seek the best consequence in the overall objective of the weapons system. Such metrics are used in PBC to measure and evaluate the effectiveness of the contracted logistics solution, which also allows any adjustments to be made during the course of the contract. There is no way to identify a perfect metric, but for each case, managers should seek to identify the most appropriate set of such elements in order to encourage the improvement of the contractor's performance, while at the same time meeting the requirements of the warfighter, which will result in a unique service, of reduced cost and higher quality (U.S. Department of Defense, 2016).

In order to implement a PBL contract with consistent metrics, all parameters considered in the contract should be analyzed in an integrated way. Some decisions can influence the metrics discussed before in opposite directions, as example, a higher level

of inventory will result in higher availability as discussed before, but means higher cost of supportability (Lopes et al., 2017).

Designing a performance-based contract, however, may be a daunting task for managers tempted to control every component of the logistics chain, willing to add more and more metrics in the agreement. Doerr et al. (2004) perfectly illustrate this dilemma on their research, as follows:

(...) if we are engaged in an initiative to buy performance, (...) wouldn't it make more sense to measure only key outcomes, and measure them well? When we first presented this idea at a conference, we were met with the objection that an abundance of measures do not necessarily distract a decision maker from key tasks. The analogy was drawn to a pilot in a jet, where the cockpit has a superabundance of meters and instruments, almost all of which can be ignored, except in the case of an emergency. The analogy is a telling one, in that most of the people making decisions about metrics for PBL have themselves been pilots, or ship captains, or in charge of some complex process in the past. However, PBL is not supposed to present the DoD with a complex process to manage – it is supposed to take one off the hands of the DoD. We aren't supposed to be flying the plane – we are supposed to be passengers. When you are paying someone else to get you to your destination, you care about the price of the ticket, and arriving on time.

### III. Methodology

#### Simulation as a logistics tool

Simulation approaches are ways to imitate the operation of real-world systems. By creating a model representing characteristics, behaviors and functions of the selected system or process, the simulation can represent the operation of the system over time. This technique is able to yield near optimal solutions when it finds the values of the system parameters that produce the desirable performance of the system. According to Rogers (2002), simulation-based optimization is a method by which an optimization engine offers the input components for the simulation program, which will go on and present the results for a previously specified objective function. Until results are shown for a satisfied solution or for termination due to prescribed conditions, the simulation process will continue iteratively between the simulation program and the optimization engine.

This methodology has long been supported in logistics applications, first, as an instrument to recognize and calculate the enhanced operation performance, and, second, as a tool to gain a sharper knowledge of the potential cost and performance of logistics operations (Bowersox & Closs, 1989). Because many logistics processes are not easily analytically traceable, simulation brings an advantage over analytical methods such as better understanding of complex systems and experiments of various systems.

In this context, computer simulation is growing in popularity as an approach for organizational researchers, which allows them to take the inherent complexity of organizational systems and to focus on “what-if” analysis, while other research methods

must make various assumptions about the exact cause and effect nature of the system under study. In fact, the key strength of simulation is its ability to support the investigation of phenomena that are difficult to study using conventional analytical methods.

### **OPUS10 Software**

In order to provide a novel analysis and a different perspective to the evaluation of possible changes on PBC performance goals, a versatile simulation tool must be chosen, with adequate capabilities to provide an insightful analysis. These requirements are well fulfilled by OPUS10, a comprehensive computer program developed by the Swedish company Systecon, with its main focus in logistics support and spares optimization.

According to Systecon (n.d.), OPUS 10 provides realistic modeling of technology and support solutions, rapid calculations, and results that significantly reduce the spare part investment while increasing system availability. It also provides indispensable decision support in a wide range of situations, like optimizing the entire maintenance concept or evaluating and comparing alternative support solutions. In addition, since it is scalable and flexible, it can handle smaller scenarios with a handful of components and a few locations to large programs with thousands of components and a complex support solution. The effective optimization algorithms make that even large cases can be optimized in seconds.

Several academic studies have been successful in assessing this tool for a wide range of logistics systems applications, as can be seen in Wu & Hsu (2008), Wijk &

Andersson (2012), (TysseLand, 2009), Lindqvist & Lundin (2010), Karlsson (2015) and Bussche (2019), among others.

OPUS10 assumes stationary conditions and that spare part demand at the operational bases can be approximated as a Poisson process. By default, the Vari-METRIC (Multi-Indenture and Multi-Echelon Technique for Recoverable Item Control) method is used, with METRIC being optional. It should also be noted that while the formulas used by OPUS10 are based on these inventory theories, they have seen considerable advancements over the years, resulting in more accurate estimates (Karlsson, 2015). However, complete and adequate descriptions of all variables considered by the cited software are not part of the scope of this research and, therefore, will not be assessed.

### **Data Used as Input**

This study mainly intends to evaluate the effects on life support costs due to the addition of metrics, or performance goals, in a PBL agreement. In this way, it would not be feasible to get real data for this kind of analysis, considering the inherent characteristics of an Air Force's operations. Information regarding cost raises due to faster return requirements imposed to contractors would also be extremely difficult to measure accurately, and would require a thorough study beyond the objectives of this research.

The scope of this investigation, in fact, comprehends the evaluation of different scenarios and values to determine a range of possible outcomes, given the limited data available. In this way, managers will be able to make the most informed decision when facing similar circumstances. For these reasons, the use of real data to evaluate the



logistical mechanisms involved in the simulations is not needed: the key here is to understand, in general, how sensitive are the life support costs to metric changes in a contract based on performance.

Therefore, this examination will consider a scenario with only one type of operating aircraft, defined as *BR-AIRCRAFT*, in a time span of five years. The annual utilization factor is defined as 0.290, resulting in 2,540 flight hours per aircraft in one year. Only failures on components will be considered (not in the system), and each system will have the item structure given shown in Figure 4, meaning that one aircraft is composed by 2 engines, 1 APU, 2 pumps, and so on. Another common feature for all models to be tested is showed on Figure 5, which provides unit prices and failure rates for each component. The failure rate (FRT) is given as the number of expected failures over a million of operating hours: thus, the engine FRT is defined as 0.00011 failures per operating hour (110 failures divided by 1,000,000 hours), for example.

	IID	MID	QTYPM	NOTE
	Subitem identifier	Motheritem or system identifier	Quantity per motheritem <1>	User Note
1	ENGINE	BR-AIRCRAFT	2	
2	APU	BR-AIRCRAFT	1	
3	CSD	BR-AIRCRAFT	2	
4	PUMP	BR-AIRCRAFT	2	
5	FCU	BR-AIRCRAFT	2	
6	STAB CTRL	BR-AIRCRAFT	1	
7	GYRO VERT	BR-AIRCRAFT	2	
8	DOOR MLG	BR-AIRCRAFT	1	
9	PITCH COMP	BR-AIRCRAFT	1	
10	FLAP ACT	BR-AIRCRAFT	1	
11				

Figure 4. OPUS10 Input Table: Materiel/ItemStructure – Quantities of items per system

	IID	DESCR	PRICE	FRT	OPID	TYPE
	Item identifier	Description	Unit price	Failure rate [1/MOPIDs]	Operation parameter identifier <OPHOURS>	Type
1	ENGINE	Jet Engine	40000.000	110.00		LRU
2	APU	Auxilliary Power Unit	6000.000	450.00		LRU
3	CSD	Constant Speed Drive	10000.000	280.00		LRU
4	PUMP	Hydr. Pump MLG	400.000	200.00		LRU
5	FCU	Flight Control Unit	4000.000	190.00		LRU
6	STAB CTRL	Stab. Controler	8000.000	360.00		LRU
7	GYRO VERT	Vertical Gyro	800.000	340.00		LRU
8	DOOR MLG	Control Mech Door MLG	1200.000	120.00		LRU
9	PITCH COMP	Pitch Computer	1600.000	1010.00		LRU
10	FLAP ACT	Flap Actuator	2400.000	240.00		LRU

Figure 5. OPUS10 Input Table: Materiel/Item – Unit prices and failure rates per item

### Scenarios to be simulated

One of the objectives of this research is to verify if PBC metrics changes will eventually be more impactful in costs for specific logistical configurations. Consequently, five different logistics scenarios will be proposed for simulation, according to Table 3. Each scenario will have a different combination of the number of operational bases (sites where aircrafts operate), depots (locations where failed items are sent from the operational bases, and where repaired components are shipped after maintenance) and workshops (repair centers) available.

For scenarios with more than one depot or workshop, specific groups of components were defined, to enable the particular flows of items through the distribution and repair sites, as identified in Table 4.

**Table 3: Logistics scenarios to be tested in OPUS10**

<i>Scenario name</i>	<i>Scenario acronym</i>	<i>Number of Workshops</i>	<i>Number of Depots</i>	<i>Number of Bases</i>	<i>Details</i>
<b>Basic Logistics Scenario</b>	<b>BLS</b>	1	1	2	12 aircrafts operating on “Near Base”, 6 aircrafts operating on “Far Base”
<b>Alternative Logistics Scenario 01</b>	<b>ALS1</b>	1	1	3	6 aircrafts operating on “Near Base”, 6 aircrafts operating on “Far Base”, 6 aircrafts operating on “Even Far Base”
<b>Alternative Logistics Scenario 02</b>	<b>ALS2</b>	1	2	2	Similar as BLS, but with Group 1 items going to Near Depot, Group 2 items going to Far Depot
<b>Alternative Logistics Scenario 03</b>	<b>ALS3</b>	2	1	2	Similar as BLS, but with Group 3 items repaired in Near Workshop, Group 4 items repaired in Far Workshop
<b>Alternative Logistics Scenario 04</b>	<b>ALS4</b>	2	2	3	Similar as ALS1, but with Group 1 items going to Near Depot, Group 2 items going to Far Depot, Group 3 items repaired in Near Workshop, Group 4 items repaired in Far Workshop

**Table 4: Specific groups for each component, when required**

<i>Item</i>	<i>Depot Group</i>	<i>Workshop Group</i>
ENGINE	Group 1	Group 3
APU		Group 4
CSD		Group 3
PUMP		Group 4
FCU		Group 3
STAB CTRL	Group 2	Group 4
GYRO VERT		Group 3
DOOR MLG		Group 4
PITCH COMP		Group 3
FLAP ACT		Group 4

### Basic Logistics Scenario (BLS)

An illustration of a possible logistics configuration for the first scenario is shown in Figure 6, containing the transportation times to move items between each site. Figure 7 shows the resultant input model in OPUS10.



Figure 6. Positioning and transportation times for the first scenario (BLS)

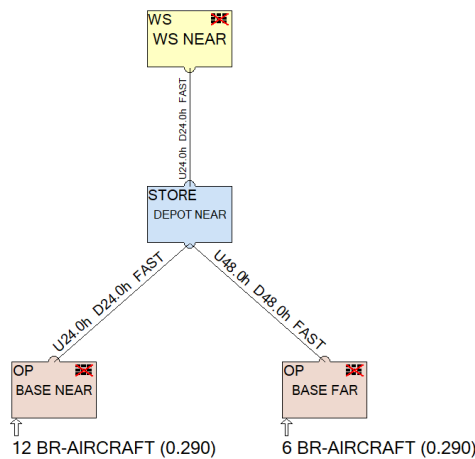

Figure 7. OPUS10 station structure for the first scenario (BLS) - both transportation times between stations (to send and return components) are considered the same

### Alternative Logistics Scenario 01 (ALS1)

Likewise, the second scenario can have its possible logistics configuration represented as shown in Figure 8, covering the transportation times to transfer items between each location. The resulting OPUS10 input model is given by Figure 9.



Figure 8. Positioning and transportation times for the second scenario (ALS1)

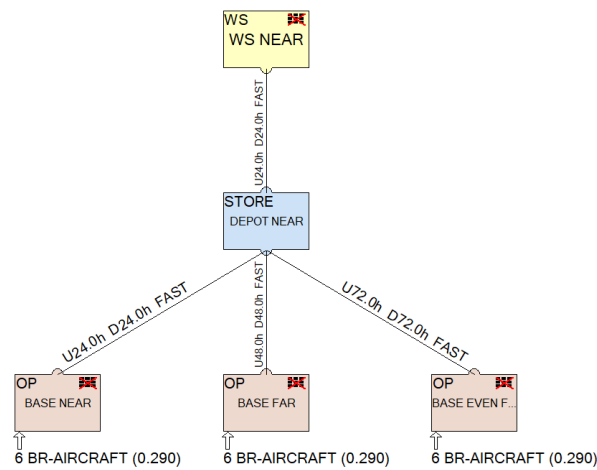

Figure 9. OPUS10 station structure for the second scenario (ALS1) - both transportation times between stations (to send and return components) are considered the same

### Alternative Logistics Scenario 02 (ALS2)

An example of a feasible logistics configuration for the third setup is demonstrated in Figure 10, including the transportation times to relocate items between each station. Figure 11 presents the resulting input model in OPUS10.



Figure 10. Positioning and transportation times for the third scenario (ALS2)

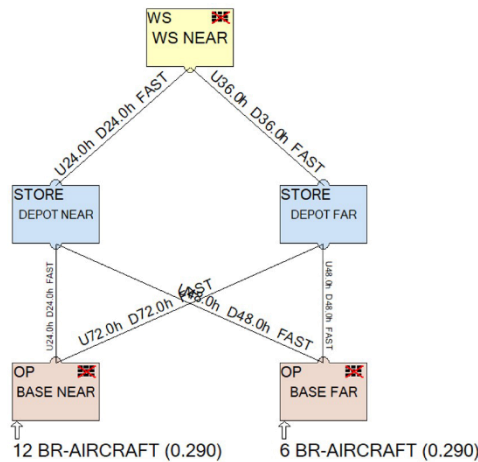

Figure 11. OPUS10 station structure for the third scenario (ALS2) - both transportation times between stations (to send and return components) are considered the same

**Alternative Logistics Scenario 03 (ALS3)**

Similarly, the fourth situation can have its potential logistics configuration characterized as displayed in Figure 12, comprising the transportation times to move items among each site. The resulting OPUS10 input model is provided by Figure 13.



Figure 12. Positioning and transportation times for the fourth scenario (ALS3)

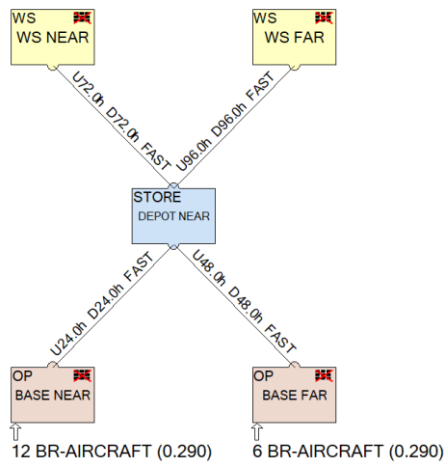

Figure 13. OPUS10 station structure for the fourth scenario (ALS3) - both transportation times between stations (to send and return components) are considered the same

### Alternative Logistics Scenario 04 (ALS4)

At last, a representation of a possible logistics configuration for the fifth scenario is exhibited in Figure 14, containing the transportation times to relocate items amongst each station. Figure 15 shows the subsequent input model in OPUS10.

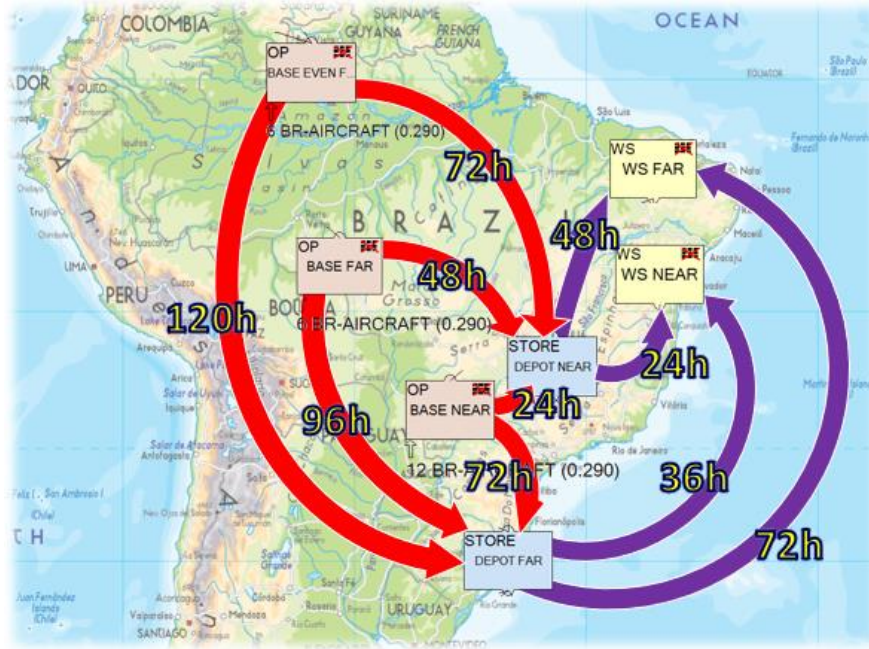

Figure 14. Positioning and transportation times for the fifth scenario (ALS4)

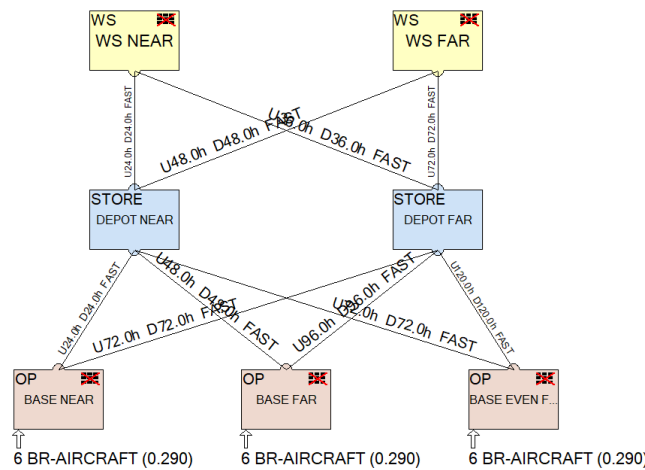

Figure 15. OPUS10 station structure for the fifth scenario (ALS4) - both transportation times between stations (to send and return components) are considered the same



## Changes on Repair Times and Costs induced by PBC Metrics in Each Scenario

Having defined all possible logistical designs, the potential changes that could be introduced in those scenarios due to performance requirements will now be introduced.

In this study, initially a logistics configuration operating with optimal performance is being considered, with an availability level of 80% for the fleet. In other words, before any specific intermediate requirement to be set by a future contract, the logistics system is operating in the best possible way and providing the desired output of 80% availability. In such condition, the simulation will assume the following values of turnaround time (TAT) and Repair Costs (RC), showed in Table 5. The initial value for the latter was defined as 25% of the unit price, for all items.

**Table 5: Turnaround Times and Repair Costs in the initial condition and at 80% availability level**

Item	Direct Repair TAT* (hours)	Direct RC (\$)
ENGINE	2000	10000
APU	1000	1500
CSD	2000	2500
PUMP	1000	100
FCU	2000	1000
STAB CTRL	1000	2000
GYRO VERT	2000	200
DOOR MLG	1000	300
PITCH COMP	2000	400
FLAP ACT	1000	600

*\*The Repair TAT here is not considering transportation times between stations, only the time spent in the workshop to repair, for simplification purposes.*

Starting from this point, high-level fleet managers make the decision to apply a PBC sustainment strategy to support that fleet. However, in an attempt to tie the contractor to some performance goals that could help them to achieve the desired supporting objectives, an intermediary metric is established in regard to the maximum

turnaround time allowed to the contractor to return a component after receiving it for repair.

As can be observed in Table 5, the initial condition of the simulation (which is considered to provide optimal performance regarding availability) shows different TAT values for each component. In an actual support organization, anyone would intuitively expect these values to be even sparser, with each item having its own intrinsic TAT to obtain an optimal output in a logistics configuration, since they all have different repair prices, stock sizes, among others.

Therefore, when a metric such as maximum allowable TAT is imposed on a performance-based contract, a certain degree of adjustment in several logistical parameters will definitely be needed to accommodate this change. In this research, it will be analyzed the impact on only one factor certainly affected by the need to reduce TAT: the repair cost. If shorter times are required, a higher cost will be charged to meet this demand.

In this study, the imposition of faster TAT will be simulated by applying the same percentage drop to all original times defined in the initial condition of the support structure. Thus, simulations will run contemplating reductions of 20% and 40% in turnaround times, modeling the effect of the imposition of a TAT metric on a logistics system that was operating in its optimal performance condition. For each of these TAT decreases, three different possible consequences on repair costs will be checked: increases of 5%, 10% and 15% in maintenance expenses.

Table 6 displays all the values that will be used as inputs, given the proposed changes discussed above.

**Table 6: Values to be tested due to TAT reductions and RC increases**

Item	Initial Condition		TAT reductions to be simulated		Possibilities of increase in Repair Cost for each TAT reduction		
	Direct Repair TAT	Direct Repair Cost	20% lower Repair TAT	40% lower Repair TAT	5% higher Repair Cost	10% higher Repair Cost	15% higher Repair Cost
ENGINE	2000	10000	1600	1200	10500	11000	11500
APU	1000	1500	800	600	1575	1650	1725
CSD	2000	2500	1600	1200	2625	2750	2875
PUMP	1000	100	800	600	105	110	115
FCU	2000	1000	1600	1200	1050	1100	1150
STAB CTRL	1000	2000	800	600	2100	2200	2300
GYRO VERT	2000	200	1600	1200	210	220	230
DOOR MLG	1000	300	800	600	315	330	345
PITCH COMP	2000	400	1600	1200	420	440	460
FLAP ACT	1000	600	800	600	630	660	690

### Model Assumptions and Limitations

The model proposed for this simulation is assuming an initial condition where the support organization is operating with optimal performance for a desired fleet availability level. In the real world, a logistics system is unlikely to operate optimally, given the extremely dynamic environment in which an aircraft fleet is inserted.

Only failures in components are being modeled, not in the aircraft itself, and the only possibility of repairing a failed item is by sending it to a workshop, so there is no possible repair on the bases or depots. Consequently, preventive or predictive maintenance are not being taken into account in this study.

The only station authorized to stock components is the depot, thus nothing can be stored on any base. Also, items can only go up to the mother station - from base to depot, and from depot to workshop - and vice-versa. Therefore, there is no lateral support, nor

cannibalization. Transportation times are considered the same for sending and returning items between stations.

The only expenditure sources are the repair costs, to fix an item in a workshop after its failure, and the acquisition costs to purchase the necessary quantity of components to be allocated in each logistical configuration, which will guarantee the system's capacity to reach the desired availability levels. Thus, several other costs are not included in this analysis, such as storage costs, man-hours costs, transportation costs, depreciation costs, among others.

Furthermore, only specific levels of changes in TAT and RC are being modeled. Any other effect in the logistical configuration due to a TAT reduction is not taken into account, only the possible impact on repair costs. For example, if the system experiences faster turnaround times, fewer items will be stored in the depot and storage costs may be reduced. Also, transportation times between stations are not being included in these TAT changes, for simplification purposes. As they are much lower than the time spent repairing items in the workshop, we consider that this assumption will not affect the analysis.

### **Experiments Simulated**

In the previous paragraphs, the five logistical configurations to be simulated were defined, as well as the changes in TAT and repair costs to be implemented in each of them, starting from an initial condition with optimal performance. However, it is also important to clarify more specifically how these changes will be gradually introduced into the simulation model.

For each logistics scenario, first all input data previously stated will be inserted, and the main output generated by running the model using OPUS10 will be a cost/effectiveness (C/E) chart like the one illustrated in Figure 16, showing all the optimal availability levels for each amount of resources – the life support costs (LSC) - to be invested in supporting the fleet’s life cycle. However, from the theory of inventory management, it is known that such graph is not a continuous curve, but a boundary created by the connection of several discrete points, each of them corresponding to a unique quantity of stock allocation among the components existing in the support organization.



Figure 16. Cost/Effectiveness (C/E) curve given as output by OPUS10 (Systecon, n.d.)

The first output generated for each scenario will show the optimal cost/availability points for a system with the entries presented in Table 3. But the focus is on the point where availability reaches the target level of 80%. As discussed, that is not a

continuous curve, so the point closest to the availability objective will be chosen, and, for this selection, there will be an unequivocal stock allocation associated with it.

This assortment of items will be the starting point for the next simulation run. The problem type will be changed from INITIAL (a short for Initial Procurement) to ANALYSIS in the OPUS10 input table *Program Control/ControlParameters*, as shown to Figure 17. In addition, the possibilities of TAT reductions and increases in repair costs will be included in the model. In this way, running the model will now provide information about LSC and the availability inherent in that specific configuration. This will be a point solution, and not a curve as in the first step. And considering the proposed simulation parameters, it is possible to postulate that a higher availability could be achieved, since the turnaround times will decrease, but also the life support costs will grow, given the increases in repair costs.

Parameter	Description	Value	Unit
STTYPE	Scenario type	<STEADY-STATE>	STEADY.STATE
PTYPE	Spares problem type	<INITIAL>	ANALYSIS
LORA-XT	Extended LORA problem scope	<N>	
PHASC	Phase scenario problem scope	<N>	
APID	Allocation Point Identifier	80	
PRMOE	Primary MoE	<A>	A
NPOINT	Number of points	<50>	200
MINLSC	Minimal LSC		
MAXLSC	Maximal LSC		
MINMOE	Minimal MoE		
MAXMOE	Maximal MoE		
STEXP	Stock policy explicitly declared	<N>	
INCEX	Include existing stock in investment	<Y>	
FOMRC	First-order model for resupply cycle	<N>	
GEMRC	Geometric compound Poisson model	<N>	
STARC	Start optimization at NRSC	<N>	
OLEVL	Optimization level	<MAX-ACCUR>	
OPPBE	Minimize probability of backorder	<N>	
OPROS	Minimize risk of shortage	<N>	
ENDEM	Endurance MoE at end of period	<N>	
ENBSS	Endurance preceded by steadystate	<Y>	

Figure 17. Change of problem type to ANALYSIS in OPUS10 to evaluate life support costs and availability for a given assortment of items

Nevertheless, there is still a need to evaluate if the point obtained in the previous step is in the optimal availability/costs boundary for that mixture of TAT/RC, and which

would be the optimal LSC value and stock allocation associated with this combination for an availability level of 80%. So, in this second step, the problem type will again be set as INITIAL, and the output will be the optimal frontier curve of availability versus LSC.

And then, running the simulation and obtaining this latest boundary, it will be possible to find the new optimal stock allocation for 80% availability. Compared with the previous step, the latter assortment of items will be reduced in quantities, making it possible to decrease LSC, although some efficiency is also lost.

As there are three different possibilities for changes in RC for each of the two TAT reductions to be tested, a total of six combinations will be verified with these exam levels. Since each of these combinations requires two steps/simulations runs to be assessed, and counting with the first simulation run for the initial logistical condition, a total of thirteen simulation runs will be needed to evaluate each logistics scenario, as listed in Table 7.

**Table 7: List of thirteen simulation runs to evaluate each logistics scenario**

# Configuration	For Each Scenario:	Sub-Scenario Acronym
1	Optimal Stock Allocation (OSA) for 80% Availability	OSA%80
2	OSA with 20% lower repair TAT, 5% higher repair costs	20T05C+80
3	New Optimal Stock Allocation with 20T05C, reducing stock allocation to 80% availability	20T05C%80
4	OSA with 20% lower repair TAT, 10% higher repair costs	20T10C+80
5	New Optimal Stock Allocation with 20T10C, reducing stock allocation to 80% availability	20T10C%80
6	OSA with 20% lower repair TAT, 15% higher repair costs	20T15C+80
7	New Optimal Stock Allocation with 20T15C, reducing stock allocation to 80% availability	20T15C%80
8	OSA with 40% lower repair TAT, 5% higher repair costs	40T05C+80
9	New Optimal Stock Allocation with 40T05C, reducing stock allocation to 80% availability	40T05C%80
10	OSA with 40% lower repair TAT, 10% higher repair costs	40T10C+80
11	New Optimal Stock Allocation with 40T10C, reducing stock allocation to 80% availability	40T10C%80
12	OSA with 40% lower repair TAT, 15% higher repair costs	40T15C+80
13	New Optimal Stock Allocation with 40T15C, reducing stock allocation to 80% availability	40T15C%80

## IV. Results and Analysis

### Comparative Results within Each Scenario

Using the guidelines presented before, all OPUS10 simulation runs were done for each of the logistics configurations, and the results are summarized from Tables 8 to 12.

It is imperative to mention that, according to the methodology previously proposed, every row in these tables corresponding to Simulation Identifiers ending in odd numbers should present information regarding an availability level of 80%. However, since the Cost/Effectiveness curve given by OPUS10 is not a continuous line, the closest point to the availability objective was chosen, as discussed earlier.

**Table 8: Numerical results obtained in BLS for each simulation run in OPUS10**

Scenario Name	Scenario/Sub-Scenario Acronym	Simulation Identifier	%Δ Repair Costs	%Δ TAT	LSC (\$)	%Δ LSC	Availability	%Δ Avail.
Basic Logistics Scenario (BLS)	BLS-1:OSA%80	A1	0%	0%	1598282.00	0.00%	79.98%	0.00%
	BLS-2:20T05C+80	A2	5%	-20%	1668415.92	4.39%	84.64%	4.66%
	BLS-3:20T05C%80	A3	5%	-20%	1619615.92	1.33%	79.91%	-0.07%
	BLS-4:20T10C+80	A4	10%	-20%	1738550.02	8.78%	84.64%	4.66%
	BLS-5:20T10C%80	A5	10%	-20%	1689750.02	5.72%	79.91%	-0.07%
	BLS-6:20T15C+80	A6	15%	-20%	1808684.11	13.16%	84.64%	4.66%
	BLS-7:20T15C%80	A7	15%	-20%	1759884.11	10.11%	79.91%	-0.07%
	BLS-8:40T05C+80	A8	5%	-40%	1668415.92	4.39%	88.07%	8.09%
	BLS-9:40T05C%80	A9	5%	-40%	1580815.92	-1.09%	80.88%	0.90%
	BLS-10:40T10C+80	A10	10%	-40%	1738550.02	8.78%	88.07%	8.09%
	BLS-11:40T10C%80	A11	10%	-40%	1650950.02	3.30%	80.88%	0.90%
	BLS-12:40T15C+80	A12	15%	-40%	1808684.11	13.16%	88.07%	8.09%
	BLS-13:40T15C%80	A13	15%	-40%	1721084.11	7.68%	80.88%	0.90%

**Table 9: Numerical results obtained in ALS1 for each simulation run in OPUS10**

Scenario Name	Scenario/Sub-Scenario Acronym	Simulation Identifier	%Δ Repair Costs	%Δ TAT	LSC (\$)	%Δ LSC	Availability	%Δ Avail.
Alternative Logistics Scenario 01 (ALS1)	ALS1-1:OSA%80	B1	0%	0%	1610681.85	0.00%	79.62%	0.00%
	ALS1-2:20T05C+80	B2	5%	-20%	1680815.94	4.35%	83.63%	4.01%
	ALS1-3:20T05C%80	B3	5%	-20%	1629615.94	1.18%	79.63%	0.01%
	ALS1-4:20T10C+80	B4	10%	-20%	1750950.03	8.71%	83.63%	4.01%
	ALS1-5:20T10C%80	B5	10%	-20%	1699750.03	5.53%	79.63%	0.01%
	ALS1-6:20T15C+80	B6	15%	-20%	1821084.12	13.06%	83.63%	4.01%
	ALS1-7:20T15C%80	B7	15%	-20%	1769884.12	9.88%	79.63%	0.01%
	ALS1-8:40T05C+80	B8	5%	-40%	1680815.94	4.35%	86.61%	6.99%
	ALS1-9:40T05C%80	B9	5%	-40%	1582415.94	-1.75%	79.49%	-0.13%
	ALS1-10:40T10C+80	B10	10%	-40%	1750950.03	8.71%	86.61%	6.99%
	ALS1-11:40T10C%80	B11	10%	-40%	1652550.03	2.60%	79.49%	-0.13%
	ALS1-12:40T15C+80	B12	15%	-40%	1821084.12	13.06%	86.61%	6.99%
	ALS1-13:40T15C%80	B13	15%	-40%	1722684.12	6.95%	79.49%	-0.13%

**Table 10: Numerical results obtained in ALS2 for each simulation run in OPUS10**

Scenario Name	Scenario/Sub-Scenario Acronym	Simulation Identifier	%Δ Repair Costs	%Δ TAT	LSC (\$)	%Δ LSC	Availability	%Δ Avail.
Alternative Logistics Scenario 02 (ALS2)	ALS2-1:OSA%80	C1	0%	0%	1614282.00	0.00%	79.00%	0.00%
	ALS2-2:20T05C+80	C2	5%	-20%	1680815.92	4.12%	82.68%	3.68%
	ALS2-3:20T05C%80	C3	5%	-20%	1637615.92	1.45%	79.58%	0.58%
	ALS2-4:20T10C+80	C4	10%	-20%	1754950.02	8.71%	82.83%	3.83%
	ALS2-5:20T10C%80	C5	10%	-20%	1707750.02	5.79%	79.58%	0.58%
	ALS2-6:20T15C+80	C6	15%	-20%	1825084.11	13.06%	82.83%	3.83%
	ALS2-7:20T15C%80	C7	15%	-20%	1777884.11	10.13%	79.58%	0.58%
	ALS2-8:40T05C+80	C8	5%	-40%	1684815.92	4.37%	85.69%	6.69%
	ALS2-9:40T05C%80	C9	5%	-40%	1590415.92	-1.48%	79.86%	0.86%
	ALS2-10:40T10C+80	C10	10%	-40%	1754950.02	8.71%	85.69%	6.69%
	ALS2-11:40T10C%80	C11	10%	-40%	1660550.02	2.87%	79.86%	0.86%
	ALS2-12:40T15C+80	C12	15%	-40%	1825084.11	13.06%	85.69%	6.69%
	ALS2-13:40T15C%80	C13	15%	-40%	1734284.11	7.43%	79.25%	0.25%



**Table 11: Numerical results obtained in ALS3 for each simulation run in OPUS10**

Scenario Name	Scenario/Sub-Scenario Acronym	Simulation Identifier	%Δ Repair Costs	%Δ TAT	LSC (\$)	%Δ LSC	Availability	%Δ Avail.
Alternative Logistics Scenario 03 (ALS3)	ALS3-1:OSA%80	D1	0%	0%	1599481.83	0.00%	79.83%	0.00%
	ALS3-2:20T05C+80	D2	5%	-20%	1669615.92	3.66%	84.52%	4.69%
	ALS3-3:20T05C%80	D3	5%	-20%	1619615.92	0.55%	79.56%	-0.27%
	ALS3-4:20T10C+80	D4	10%	-20%	1739750.02	8.01%	84.52%	4.69%
	ALS3-5:20T10C%80	D5	10%	-20%	1689750.02	4.91%	79.56%	-0.27%
	ALS3-6:20T15C+80	D6	15%	-20%	1809884.11	12.37%	84.52%	4.69%
	ALS3-7:20T15C%80	D7	15%	-20%	1759884.11	9.26%	79.56%	-0.27%
	ALS3-8:40T05C+80	D8	5%	-40%	1669615.92	3.66%	87.99%	8.16%
	ALS3-9:40T05C%80	D9	5%	-40%	1580815.92	-1.85%	80.36%	0.53%
	ALS3-10:40T10C+80	D10	10%	-40%	1739750.02	8.01%	87.99%	8.16%
	ALS3-11:40T10C%80	D11	10%	-40%	1650950.02	2.50%	80.36%	0.53%
	ALS3-12:40T15C+80	D12	15%	-40%	1809884.11	12.37%	87.99%	8.16%
	ALS3-13:40T15C%80	D13	15%	-40%	1721084.11	6.85%	80.36%	0.53%

**Table 12: Numerical results obtained in ALS4 for each simulation run in OPUS10**

Scenario Name	Scenario/Sub-Scenario Acronym	Simulation Identifier	%Δ Repair Costs	%Δ TAT	LSC (\$)	%Δ LSC	Availability	%Δ Avail.
Alternative Logistics Scenario 04 (ALS4)	ALS4-1:OSA%80	E1	0%	0%	1662681.85	0.00%	81.16%	0.00%
	ALS4-2:20T05C+80	E2	5%	-20%	1732815.94	4.22%	84.87%	3.71%
	ALS4-3:20T05C%80	E3	5%	-20%	1661615.94	-0.06%	79.99%	-1.17%
	ALS4-4:20T10C+80	E4	10%	-20%	1802950.03	8.44%	84.87%	3.71%
	ALS4-5:20T10C%80	E5	10%	-20%	1731750.03	4.15%	79.99%	-1.17%
	ALS4-6:20T15C+80	E6	15%	-20%	1873084.12	12.65%	84.87%	3.71%
	ALS4-7:20T15C%80	E7	15%	-20%	1801884.12	8.37%	79.99%	-1.17%
	ALS4-8:40T05C+80	E8	5%	-40%	1732815.94	4.22%	87.43%	6.27%
	ALS4-9:40T05C%80	E9	5%	-40%	1611615.94	-3.07%	80.47%	-0.69%
	ALS4-10:40T10C+80	E10	10%	-40%	1802950.03	8.44%	87.43%	6.27%
	ALS4-11:40T10C%80	E11	10%	-40%	1681750.03	1.15%	80.47%	-0.69%
	ALS4-12:40T15C+80	E12	15%	-40%	1873084.12	12.65%	87.43%	6.27%
	ALS4-13:40T15C%80	E13	15%	-40%	1751884.12	5.36%	80.47%	-0.69%

All the five logistics scenarios should be analyzed starting from the initial setup (Simulation Identifiers equal to 1) and, for every interrelated change that occur in TAT/RC, a pair of simulation runs were done. Thus, for example, when analyzing the effect in the Basic Logistics Scenario (BLS) of a 20% reduction in TAT, considering a 5% increase in RC, the evaluation starts from simulation A1, and the required *first step* is to run simulation A2, resulting in both higher availability and life support costs, using the same stock allocation as in A1. The *second step* is to go from A2 to A3 simulation, where a new optimal combination of availability and costs is achieved, reducing the quantities in the assortment of items.

In the following figures, showing OPUS10 outputs for all scenarios and parameter changes, it will be possible to graphically visualize the effects of the changes induced by the *first* and *second steps*, always starting from the initial setup.

### BLS Results

Figure 18 shows the output curves and points generated by OPUS10 after running simulations for 20% TAT reductions for all three possible increases in repair costs, comparing them with the initial setup. In Figure 19 a detailed view of the changes is shown, keeping only the optimal points closest to the targeted availability level of 80%.

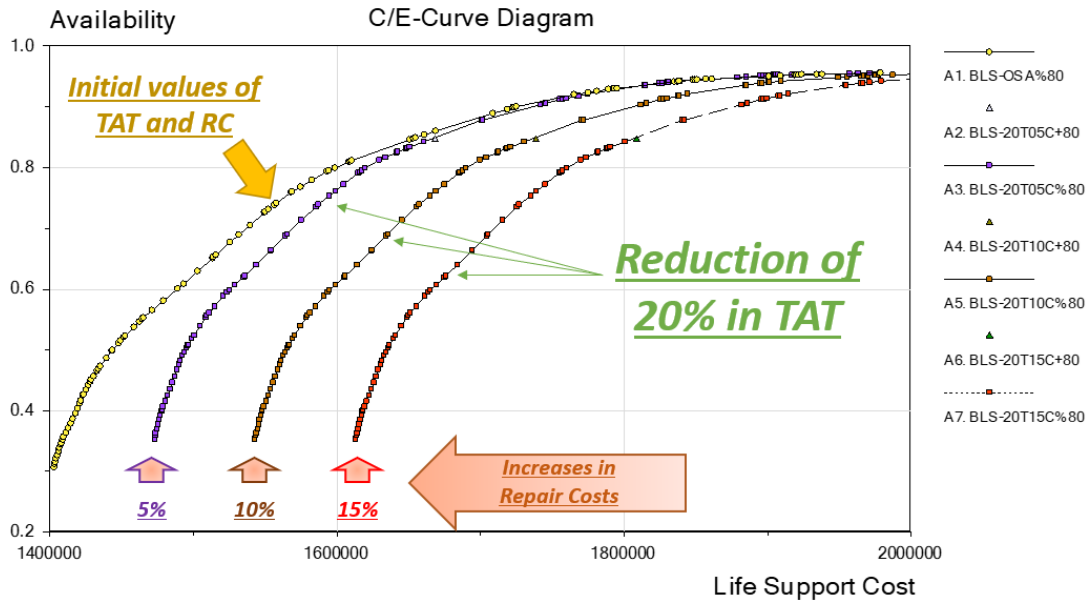

Figure 18. OPUS10 output C/E curves and points for a 20% TAT reduction in BLS

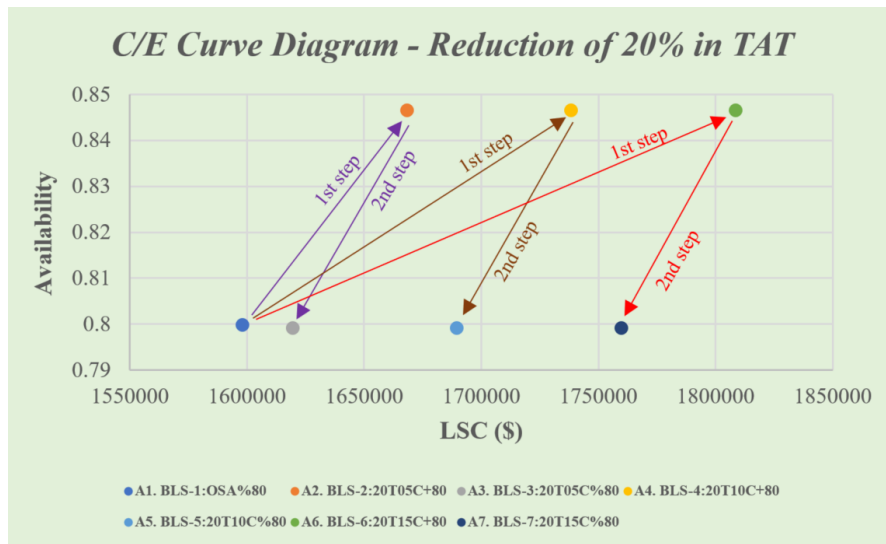

Figure 19. Detailed view of the points of interest for a 20% TAT reduction in BLS

In the same way, Figure 20 shows the output curves and points generated by OPUS10 after running simulations for 40% TAT cuts for all three possible rises in RC, comparing them with the initial setup. Figure 21 shows a detailed view of the changes, retaining only the optimal points closest to the targeted availability level of 80%.

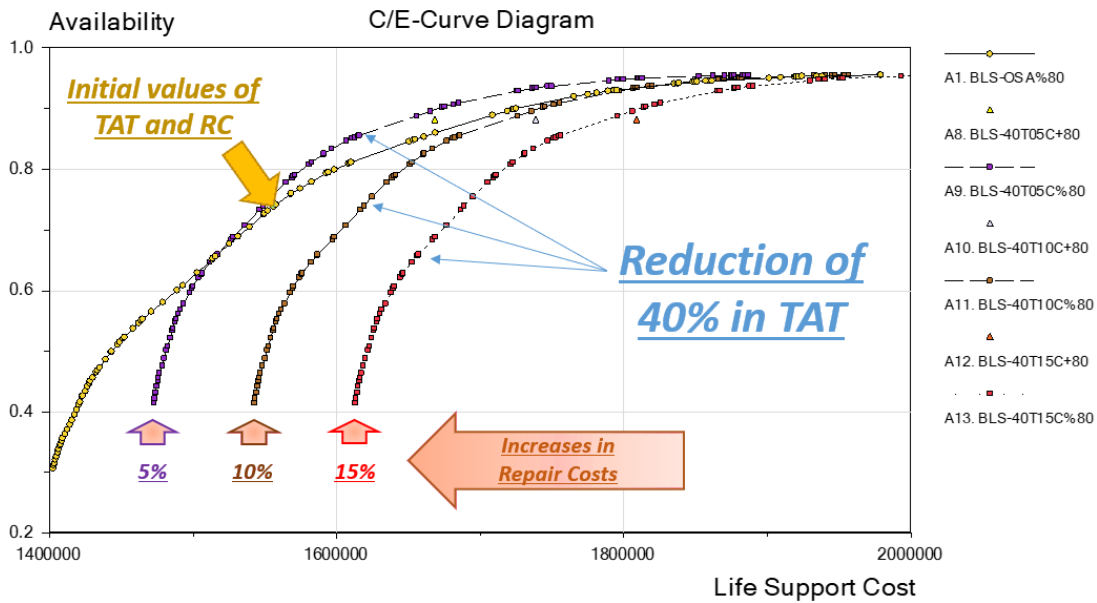

Figure 20. OPUS10 output C/E curves and points for a 40% TAT reduction in BLS

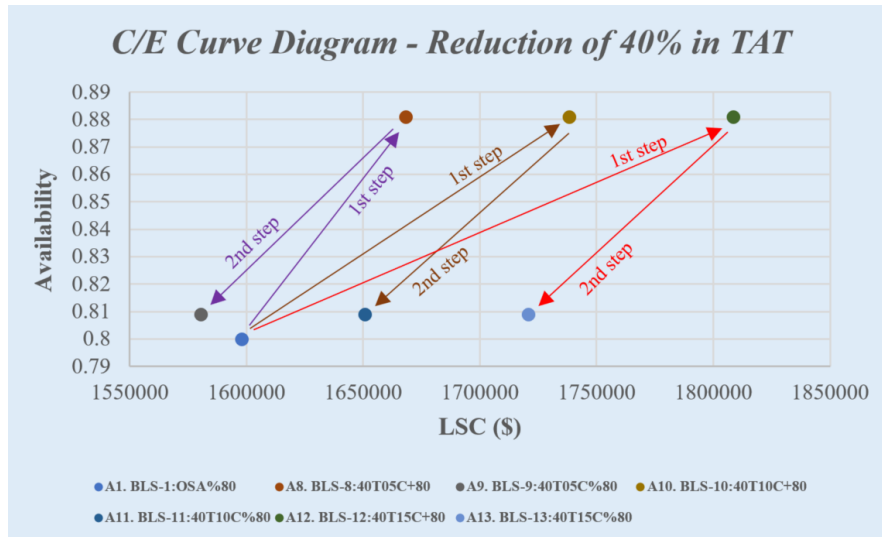

Figure 21. Detailed view of the points of interest for a 40% TAT reduction in BLS

### ALS1 Results

The output curves and points produced by OPUS10 after running simulations for 20% TAT drops for all three possible increases in RC in shown in Figure 22, comparing them with the initial situation. A detailed view of the changes is presented in Figure 23, maintaining only the optimal points closest to the 80% availability level.

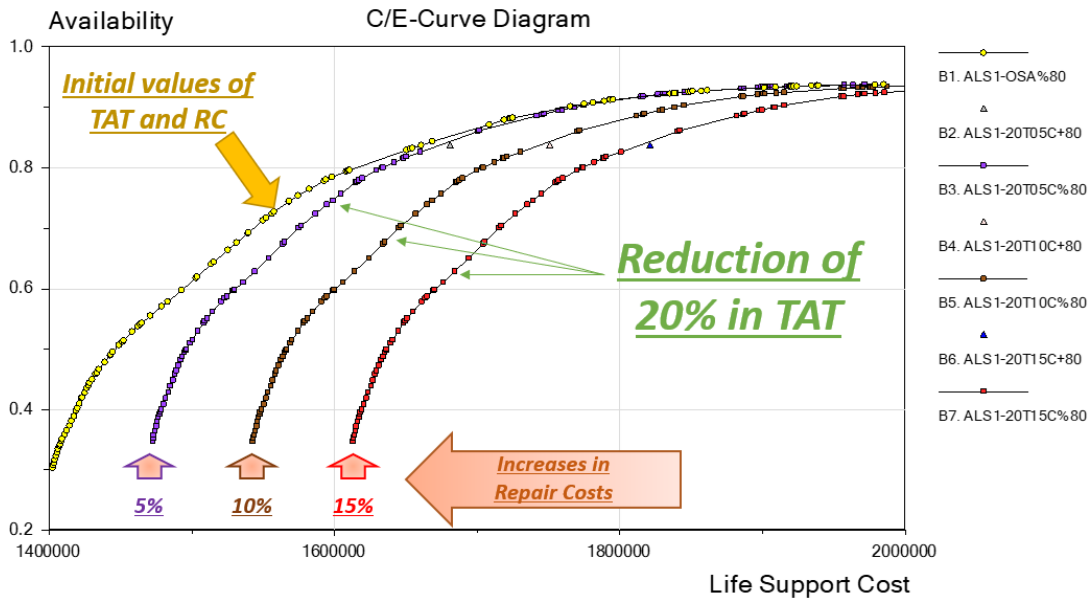

Figure 22. OPUS10 output C/E curves and points for a 20% TAT reduction in ALS1

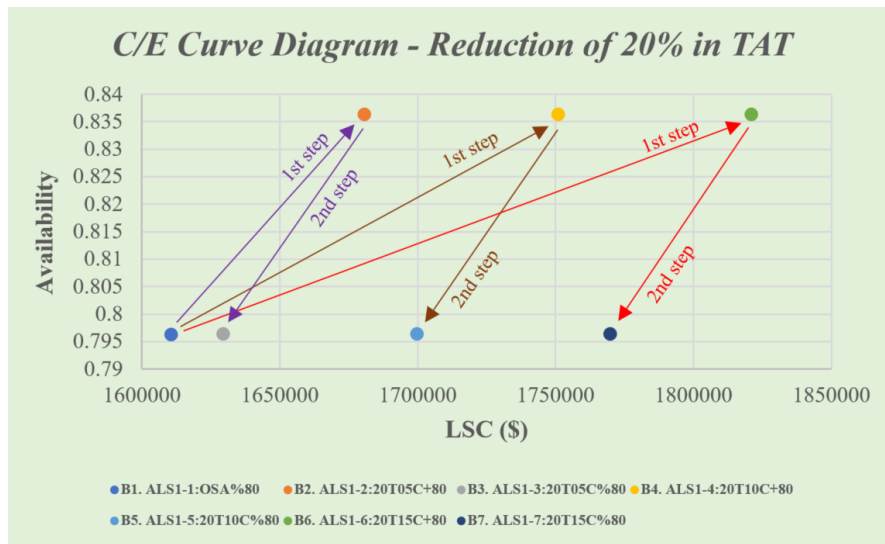

Figure 23. Detailed view of the points of interest for a 20% TAT reduction in ALS1

Similarly, Figure 24 shows the output curves and points generated by OPUS10 after running simulations for 40% TAT reductions for all three possible escalations in repair costs, comparing them with the initial setup. Figure 25 shows a detailed view of the changes, preserving only the optimal points closest to the availability goal of 80%.

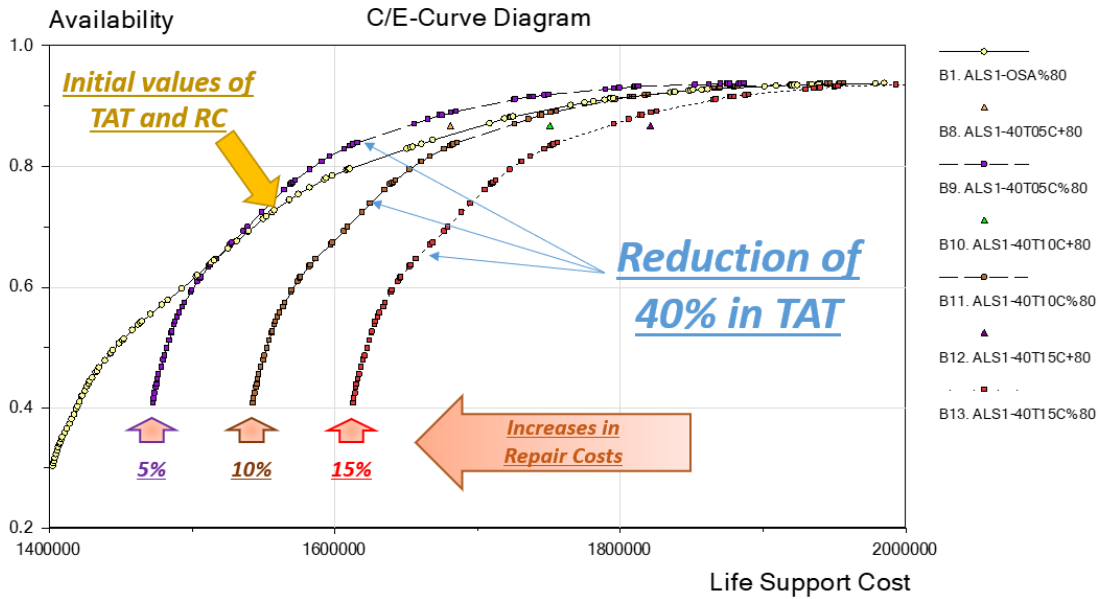

Figure 24. OPUS10 output C/E curves and points for a 40% TAT reduction in ALS1

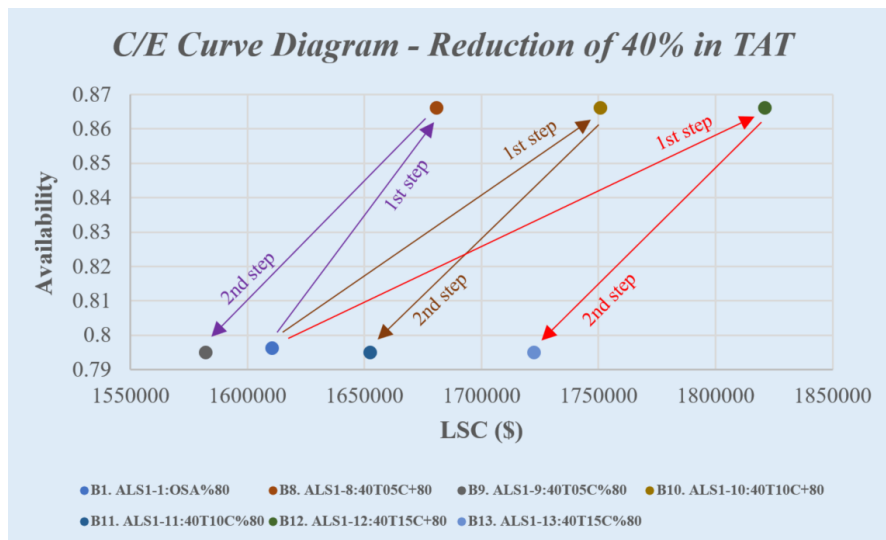

Figure 25. Detailed view of the points of interest for a 20% TAT reduction in ALS1

## ALS2 Results

OPUS10 output curves and points are given by Figure 26, after running simulations for 20% TAT reductions for all three possible increases in RC, comparing them with the initial setup. In Figure 27 a detailed view of the changes is shown, keeping only the optimal points nearest to the pursued availability level of 80%.

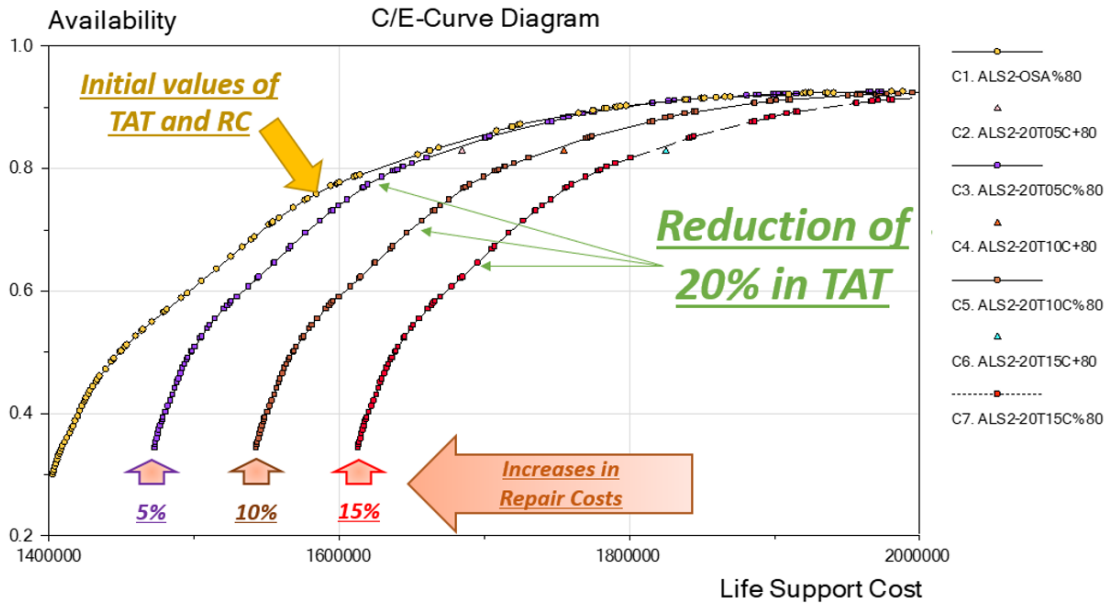

Figure 26. OPUS10 output C/E curves and points for a 20% TAT reduction in ALS2

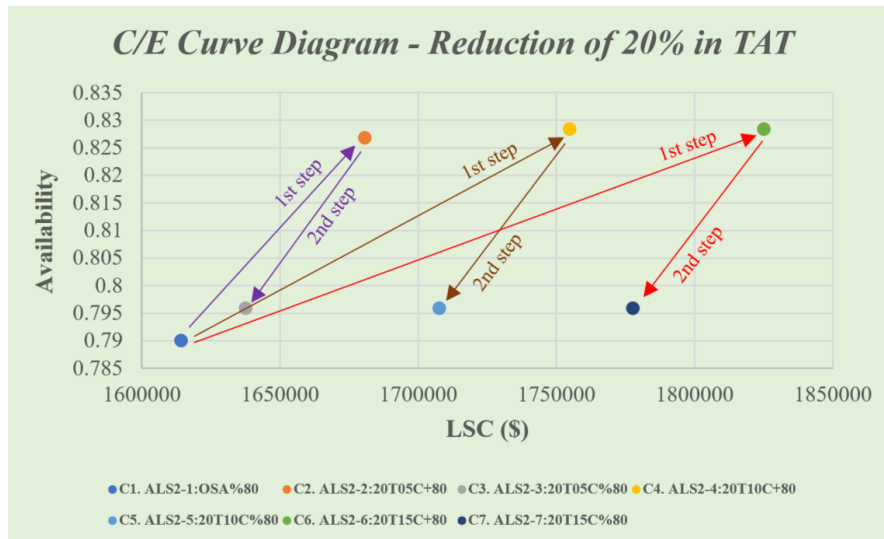

Figure 27. Detailed view of the points of interest for a 20% TAT reduction in ALS2

Likewise, Figure 28 illustrates the output curves and points made by OPUS10 when running simulations for 40% TAT reductions for all three possible increases in repair costs, contrasting them with the original setup. A detailed view of the changes is exhibited in Figure 29, retaining just the optimal points closest to the targeted availability of 80%.

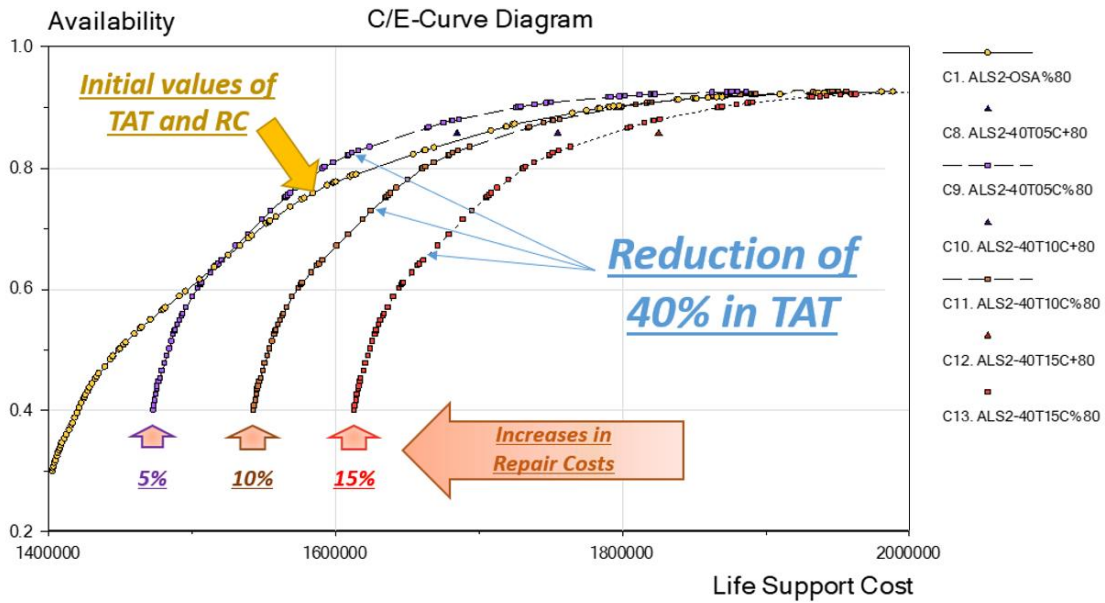

Figure 28. OPUS10 output C/E curves and points for a 40% TAT reduction in ALS2

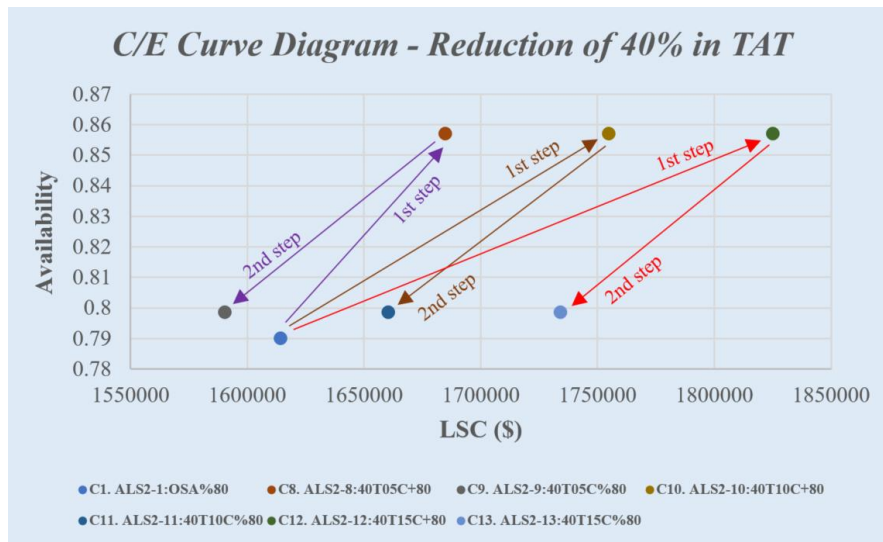

Figure 29. Detailed view of the points of interest for a 40% TAT reduction in ALS2

### ALS3 Results

The output given by OPUS10 after running simulations for 20% TAT decreases for all three potential increases in repair costs is displayed in Figure 30, comparing them with the initial system. Figure 31 presents a detailed view of the changes, keeping just the optimal points adjacent to the 80% availability mark.

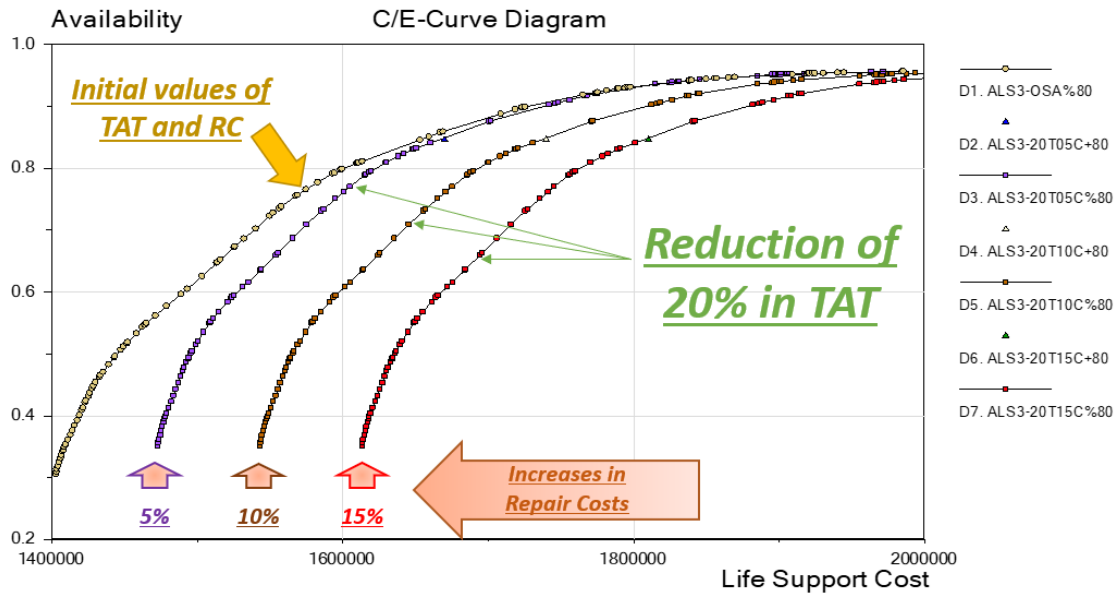

Figure 30. OPUS10 output C/E curves and points for a 20% TAT reduction in ALS3

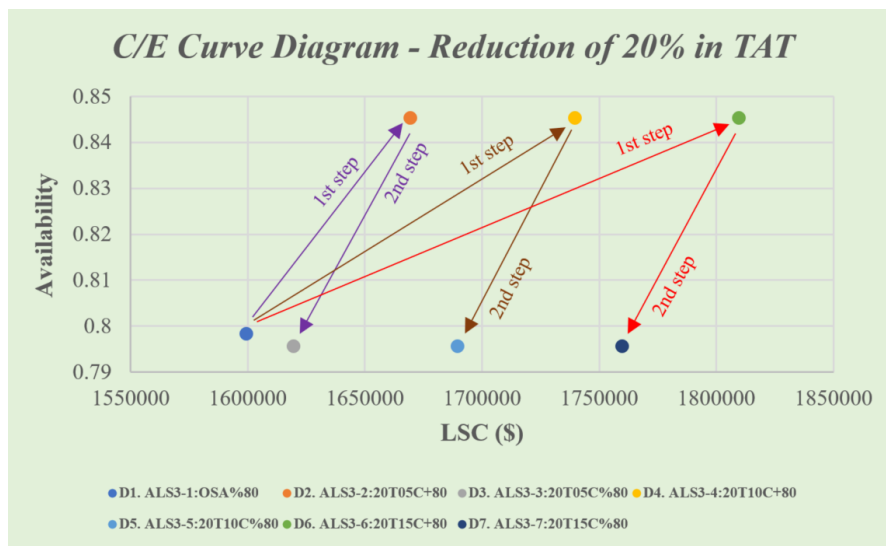

Figure 31. Detailed view of the points of interest for a 20% TAT reduction in ALS3



Subsequently, Figure 32 reveals the output curves and points produced by OPUS10 after running simulations for 40% TAT decreases for all three possible raises in RC, contrasting them with the initial arrangement. Figure 33 illustrates a detailed picture of the modifications, staying only the optimal points closest to the pursued availability level of 80%.

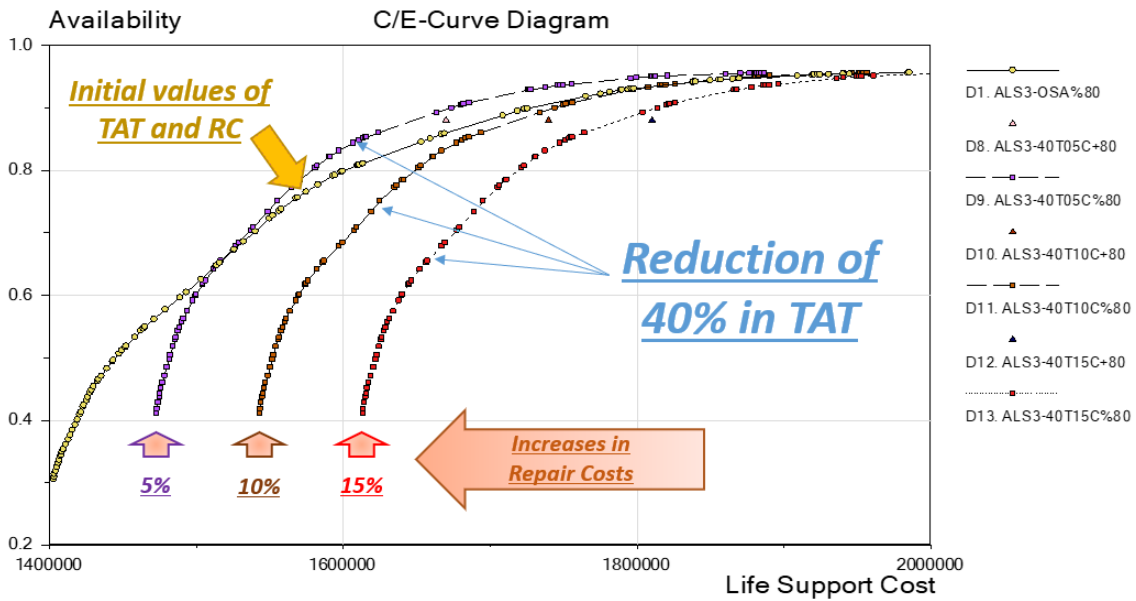

Figure 32. OPUS10 output C/E curves and points for a 40% TAT reduction in ALS3

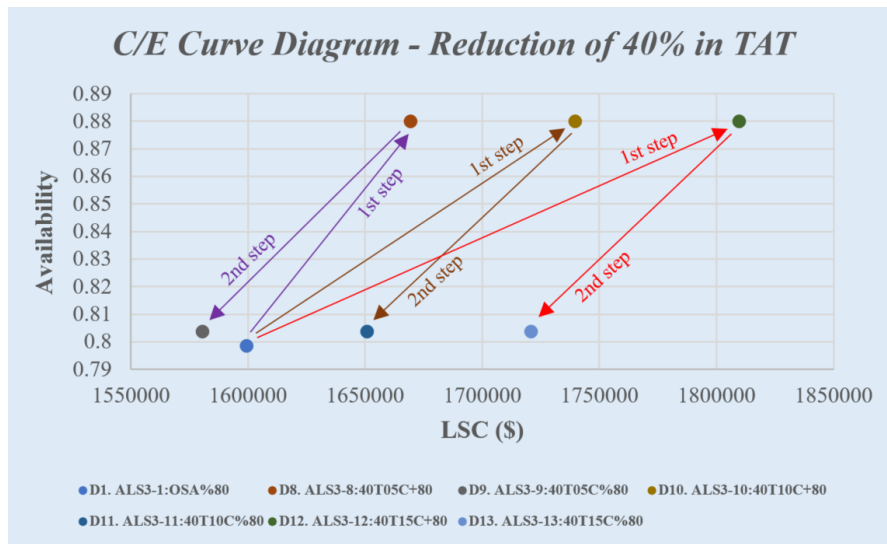

Figure 33. Detailed view of the points of interest for a 4% TAT reduction in ALS3

### ALS4 Results

Figure 34 indicates the outputs offered by OPUS10 following simulation runs for 20% TAT decreases for all three possible increases in repair costs, comparing them with the opening setup. In Figure 35 a detailed picture of the changes is displayed, keeping only the optimal points closest to the availability target of 80%.

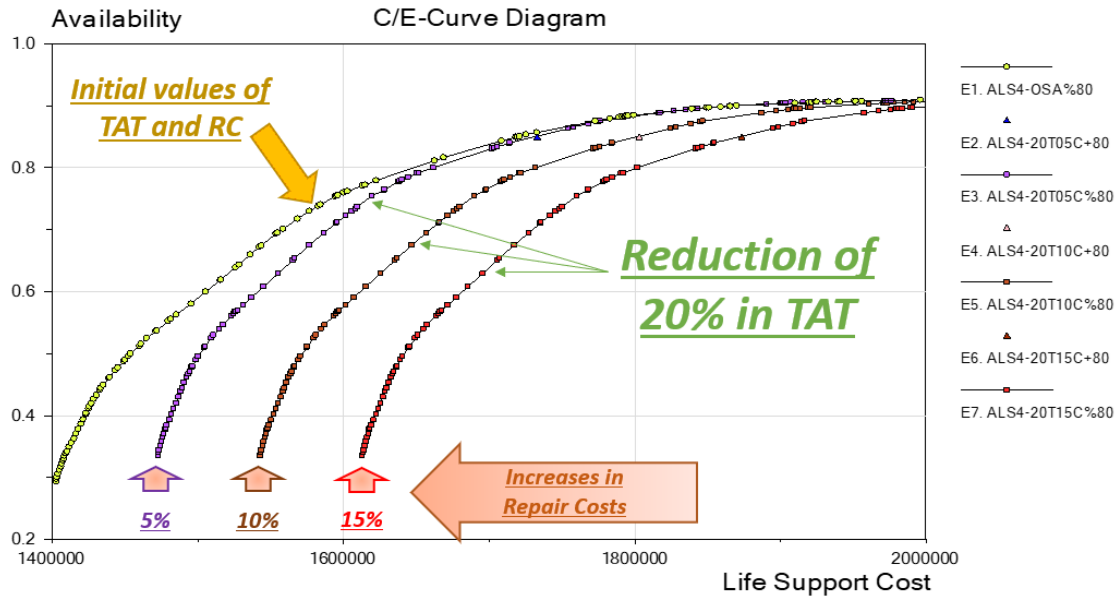

Figure 34. OPUS10 output C/E curves and points for a 20% TAT reduction in ALS4

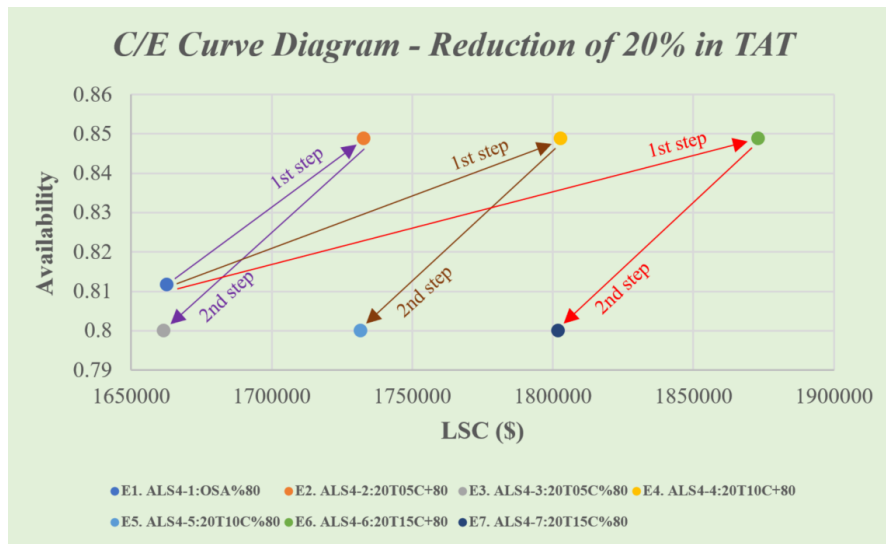

Figure 35. Detailed view of the points of interest for a 20% TAT reduction in ALS4

Also, Figure 36 illustrates the output curves and points generated by OPUS10 after doing simulations for 40% TAT reductions for all three potential increases in repair costs, comparing them with the initial procedure. Figure 37 shows a precise view of the variations, maintaining only the optimal points nearest to the targeted availability level of 80%.

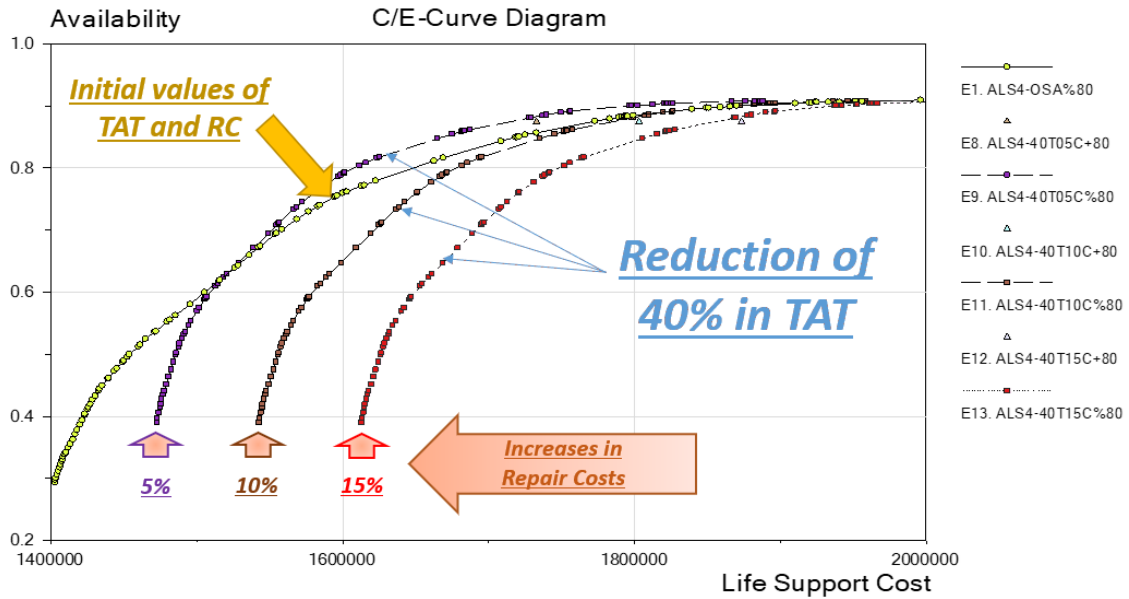

Figure 36. OPUS10 output C/E curves and points for a 40% TAT reduction in ALS4

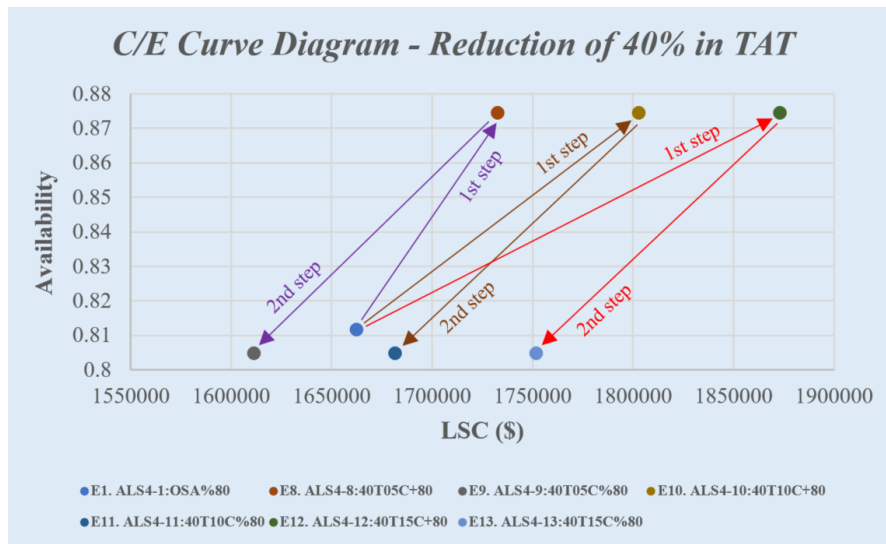

Figure 37. Detailed view of the points of interest for a 40% TAT reduction in ALS4

### *Analysis of the Results within Each Scenario*

From the simulation outputs presented, it can be noticed that, in most cases, the LSC will be higher when a TAT reduction is enforced in the logistics system. However, when a TAT reduction of 40% is followed by an increase of only 5% in RC, life support costs may even be less than in the original logistics setup.

A better view of the effects on LSC of the different tested combinations of TAT and RC changes is provided in Figures 38 to 42. Ideally, these charts should contain only information regarding logistical configurations corresponding to exactly the same availability, which would be the 80% target. But this is nearly impossible in practical terms, since the optimal cost-effectiveness curve is not continuous, but a discrete sequence of points.

For this reason, the curves shown in the following figures are only reasonable approximations to allow comparison, because the hypothetical accurate curves should represent the values for exactly the same availability as the original setup. The arrows in the charts point to the directions where the curves should be slightly moved to reflect the same availability as the initial test configuration.

Taking Figure 38 as an example, the curve for a 20% TAT reduction should be moved smoothly upwards, since it represents an availability 0.07% lower than the original setup; therefore, to achieve the same level of availability, the cost would be a little percentage higher. In the same figure, the curve for a 40% TAT reduction should be gently moved in the opposite direction, as it is given for an availability 0.90% higher than the initial configuration; hence, to accomplish equivalent availability the cost would be a bit lower. The same reasoning can be applied to Figures 39 to 42.

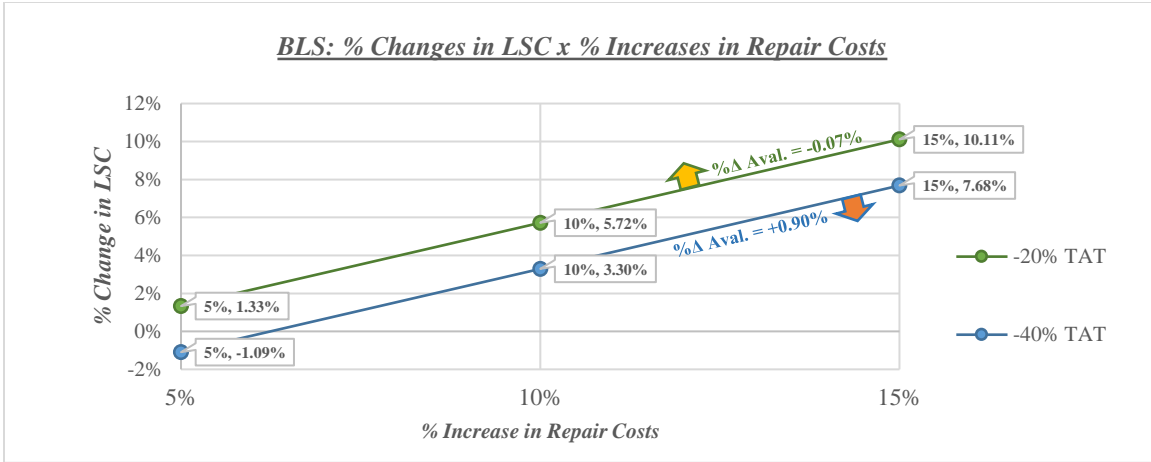

Figure 38. BLS: Effect on LSC of different mixes of TAT and RC changes

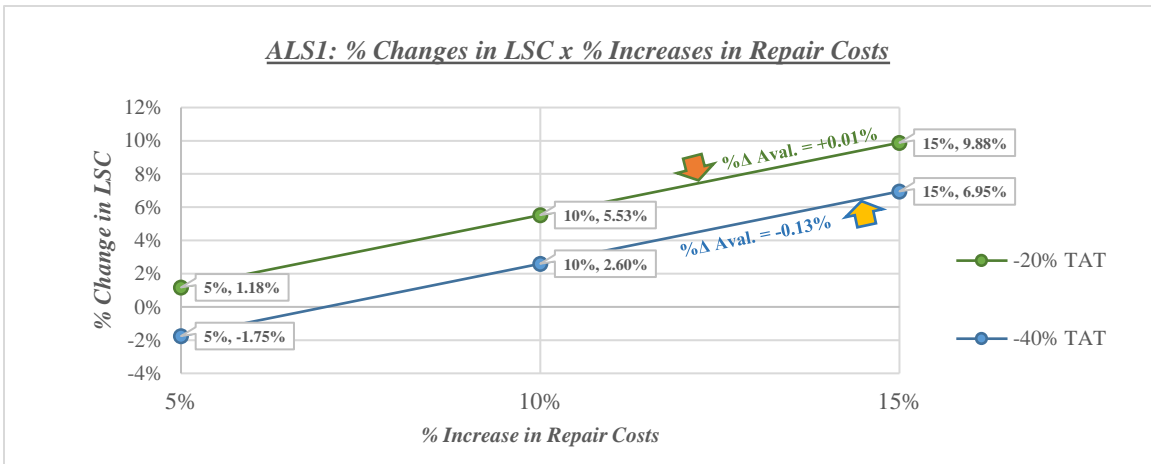

Figure 39. ALS1: Effect on LSC of different mixes of TAT and RC changes

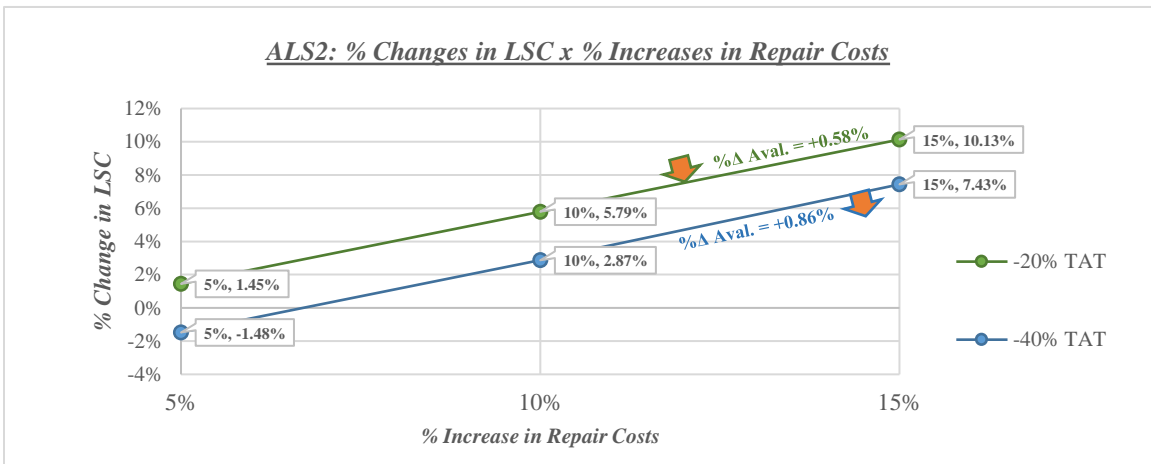

Figure 40. ALS2: Effect on LSC of different mixes of TAT and RC changes

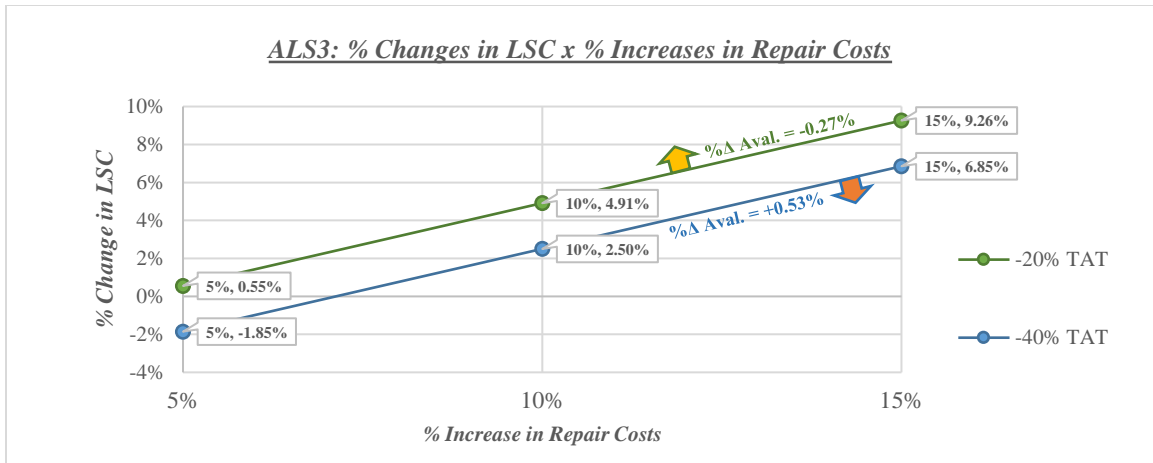

Figure 41. ALS3: Effect on LSC of different mixes of TAT and RC changes

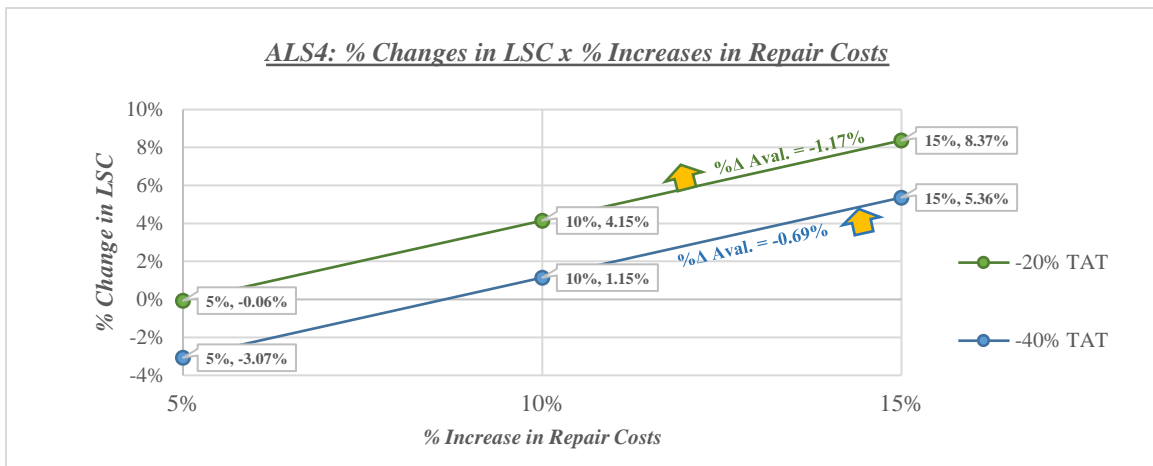

Figure 42. ALS4: Effect on LSC of different mixes of TAT and RC changes

Another remarkable mechanism to be discussed involves the dynamics between the *first* and *second steps*, as detailed in Figures 19 to 37. In an actual logistics system, it is not so easy to naturally navigate among these configuration changes. If all items are obliged to move faster in the logistics chain by reducing TAT requirements, intuitively there will be a positive effect on availability.

However, this additional effort will certainly be accompanied by cost increases, as discussed earlier. And considering only the parameters debated in this study, the only

way to compensate this addition in the LSC would be to reduce the existing stock of components available to support the fleet, otherwise they would represent an additional cost now unnecessary, since that extra availability is not necessary: the operational requirement is 80%, anything beyond that is just a superfluous cost.

Thus, to return to an optimal mix of LSC and availability, managers would need to discard excess items, recovering the same amount invested in the acquisition of these components. Despite this being an unrealistic assumption, it was taken as true for in this study. Therefore, in a real system, it would be necessary to take into account the depreciation costs on the items already put in service and now no longer needed, and that would eventually be sold to some other user, or returned to the manufacturer by recovering a portion of the amount invested in its acquisition, for example.

Again, in the real world this recapitalization process is quite complex, and even unusual. Therefore, the chances are that costs would only increase considerably, virtually acquiring a greater capacity to achieve higher availability rates, even though this resource is being committed to a completely unnecessary capacity.

### **Comparative Results among Different Scenarios**

To allow a comparison amongst all the tested logistics scenarios, OPUS10 was used to build the chart in Figure 43, where it is possible to verify that ALS4 has the highest intrinsic life support costs, followed by ALS2, ALS1, ALS3 and finally by BLS, which is the most economical configuration.

On Table 13, a rough evaluation between the configurations corresponding to the availability level closest to 80% is shown, where the same order of costs described above can be verified. It can be seen that BLS and ALS3 have very close results, while ALS1

and AL2 would be at a slightly higher level (with costs around 1% higher), and finally ALS4 would result in costs significantly higher, around 4% more than the most economical configuration. Again, it is necessary to remember that an exact comparison is not possible, given the discrete characteristic of the output C/E curve. An interpolation could be done to find approximate LSC values for exactly 80% availability, but the analysis would be no different.

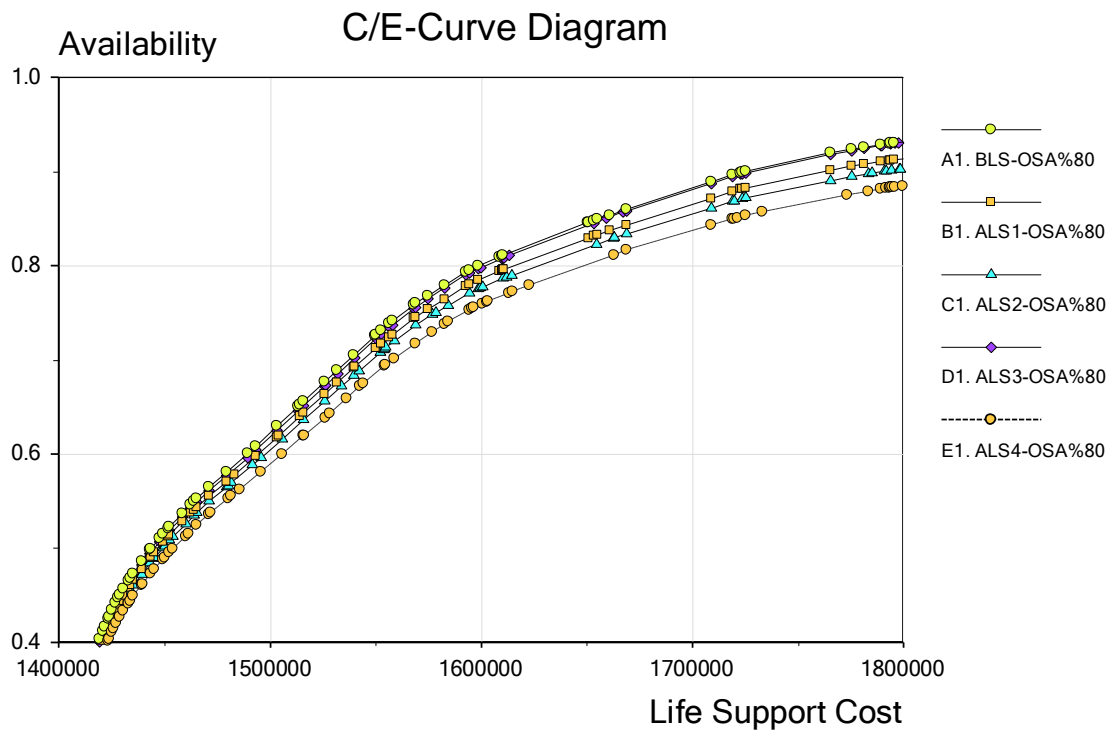

Figure 43. Comparison between C/E curves for initial setups, in each logistics scenario

Table 13: Comparison among initial setup values with availability closer to 80%, in each scenario

Scenario	Scenario/Sub-Scenario Acronym	Simulation Identifier	LSC (\$)	%Δ LSC	Availability	%Δ Avail.
<b>BLS</b>	BLS-1:OSA%80	A1	1598282.00	<b>0.00%</b>	79.98%	<b>0.00%</b>
<b>ALS1</b>	ALS1-1:OSA%80	B1	1610681.85	<b>0.78%</b>	79.62%	<b>-0.36%</b>
<b>ALS2</b>	ALS2-1:OSA%80	C1	1614282.00	<b>1.00%</b>	79.00%	<b>-0.98%</b>
<b>ALS3</b>	ALS3-1:OSA%80	D1	1599481.83	<b>0.08%</b>	79.83%	<b>-0.15%</b>
<b>ALS4</b>	ALS4-1:OSA%80	E1	1662681.85	<b>4.03%</b>	81.16%	<b>1.18%</b>



Another aspect to be observed here is how each of the tested logistical configurations responds to the proposed changes in TAT and repair costs. Figure 44 and Figure 45 are presenting the effect on LSC of the tested percentage increases in RC, for TAT reductions of 20% and 40%, respectively.

In these illustrations, it can be clearly seen that the positive effect of reducing TAT, compared to the negative consequences of increases in repair costs, is greater for the ALS4 scenario than for the others. For a 20% TAT reduction, the ALS3 scenario also presents a noticeable better response compared to the latter scenarios, but going to a 40% TAT reduction this scenario provides results similar to ALS1, although still slightly better than ALS2 and BLS configurations.

Therefore, there is evidence that a support organization containing more workshops (as is the case of ALS3 and ALS4) would be more positively affected by TAT reductions than the others, experiencing proportionally lower raises in the LSC. In addition, there is an indication that more complex logistical configuration would respond better to the proposed changes, given the noticeable differences between BLS and ALS4 results, for example.

Once again it is needed to remember that these charts should comprise only data concerning logistical configurations relating to exactly the same value of 80% availability. As debated before, this is virtually impossible in practical terms, and, due to this reason, the curves shown in the following figures are only rough approximations to allow comparison, since the hypothetical precise curves should display the values for exactly the same availability than in the initial configuration. The arrows next to each scenario identifier in the legend of Figure 44 and Figure 45 are indicating the directions

to which the curves should be slightly translated to reflect the same availability as the initial test configuration, according to the data provided in Tables 8 to 12.

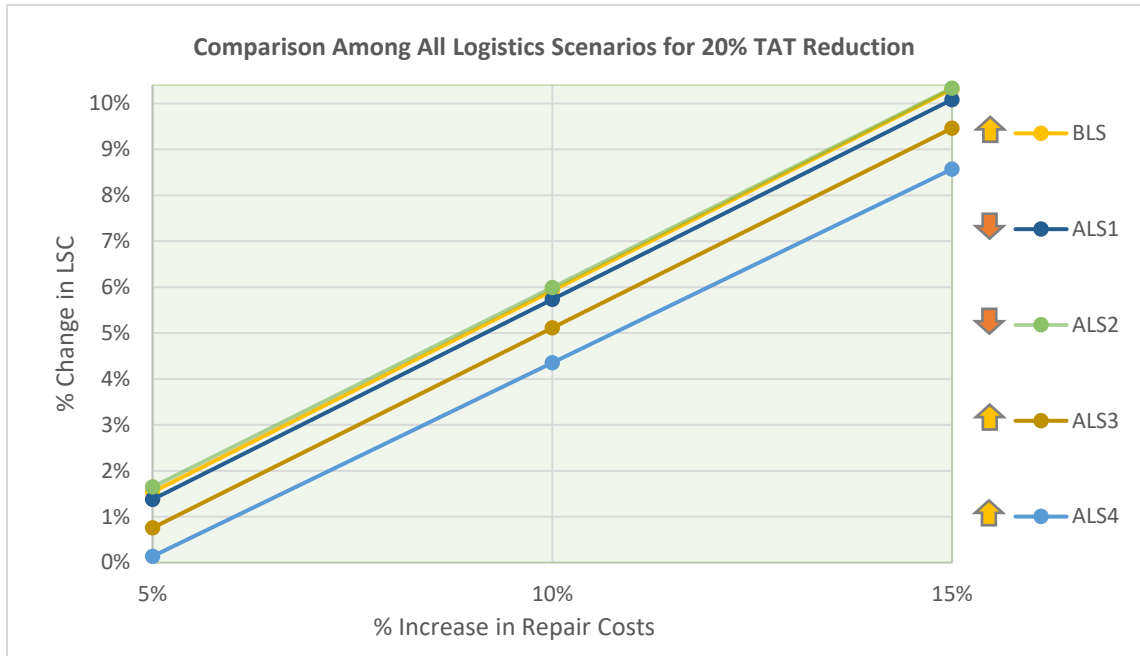

Figure 44. Comparison between tested logistics scenarios, given a 20% TAT reduction

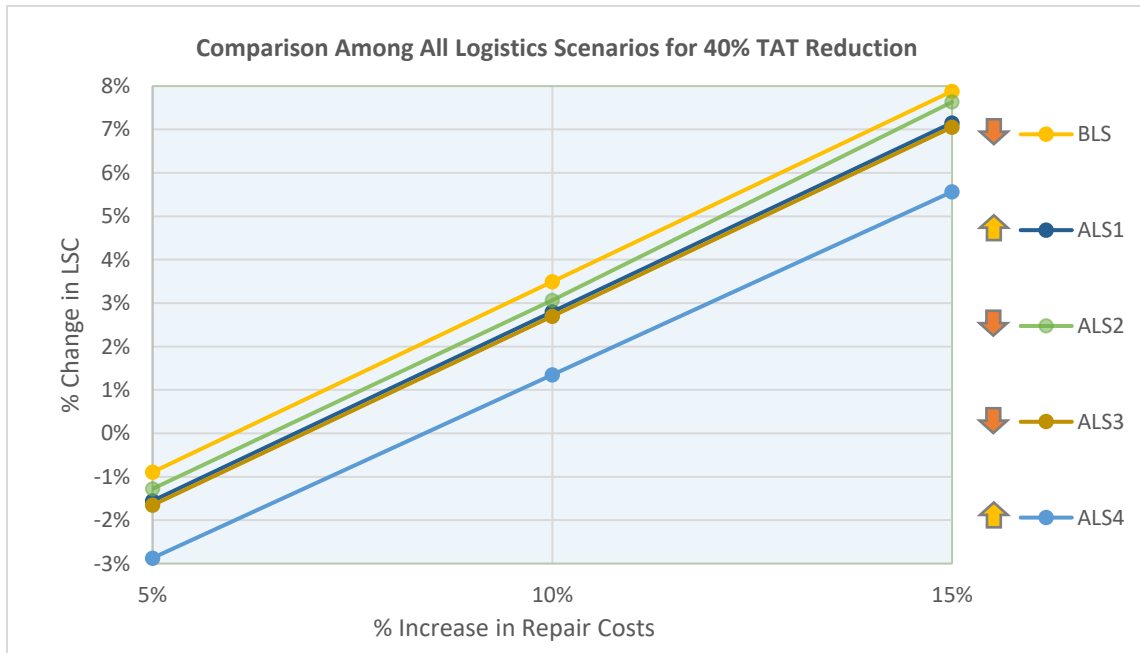

Figure 45. Comparison between tested logistics scenarios, given a 40% TAT reduction

## **Analysis of Research/Investigative Questions**

After thoroughly discussing the simulation results, the research and investigative questions proposed earlier in this study can be reviewed and discussed properly.

### ***RQ: How sensitive are the Life Support Costs to the addition of metrics in a Performance Based Contract?***

For the conditions tested, it was possible to conclude that life support costs were strongly sensitive to the addition of a metric that imposed a shorter turnaround time (TAT) for the components to return from repair in any workshop, which was detailed in the numerical results given by Tables 8 to 12. Although the magnitude is unique for every particular scenario, the trends in percentage changes in LSC are similar among them, with subtle differences in the slopes of the curves shown in Figures 38 to 42.

### ***IQ1: How does imposing a metric on the maximum turn-around time to repair a component affect LSC?***

This research was able to show how the enforcement of a metric on the maximum TAT to repair a component affected LSC, which in most cases became higher when a lower TAT was applied. Since this obligation will certainly result in higher costs for the contractor responsible for maintaining and transporting such components, these extra expenses will be charged to the final customer.

However, it was also possible to identify some simulations in which a lower LSC was achieved, all of them when repair costs were increased by the lower amount of 5%. This occurred for both the 20% and 40% TAT reductions tested in the ALS4 scenario, and also in all other tested scenarios, when the 40% TAT reduction was accompanied by only a 5% increase in RC.

In a real logistics system, though, the reductions in turnaround times simulated in this study would hardly correspond to such a small growth in repair costs. Therefore, scenarios in which a reduction in LSC occurs by imposing a reduction in TAT, although possible, are very unlikely.

***IQ2: Are these possible effects more sensitive in specific logistic configurations?***

Now reviewing the comparison among the different scenarios designed for this study, the simulation offered evidences to support the idea that more complex logistical configurations will present a better response to TAT reductions, getting lower percentage increases in LSC.

But while ALS4, the most complex scenario, is also the one with highest absolute life support costs, the ALS3 configuration presented absolute LSC values very similar to the most basic scenario (BLS), as can be seen in Figure 43 (the BLS and ALS3 curves are practically the same). With this finding, it is possible to postulate that ALS3, the scenario with fewer operating bases and depots, and more workshops, would be the most recommended configuration for this logistics system, as it would have lower absolute life support costs and would respond better to changes in the TAT/RC mix.

### **Expanding the Interpretation for Different Changes in Logistics Configuration**

The simulation experiment created for this research only took into account only one possible metric that could be affected by a performance-based contract design decision: the turnaround times (TAT). Nevertheless, there are several different processes making part of the logistics support chain that could be measured and whose desired minimum operating parameters could be established by a contract.

For instance, imagining a situation where fleet managers are designing a PBC to provide almost complete logistics support to an aircraft fleet (including component repair, supply of spare parts, obsolescence management, manpower to carry out major aircraft inspections, among others), they could feel that not only the amount of time an item should take to return after being sent for repair should be limited (as simulated in this study), but also that an aircraft should not take more than, for example, 100 days in maintenance. Worried with possible delays on the spare parts shipments, they also create an additional metric stating that the contractor must deliver every part in not more than, say, 50 days. Another possible concern could motivate a limitation on the maximum number of backorders allowed, assuring a certain fill rate level. Ultimately, many other parameters could be controlled in such a logistical support contract.

Absolutely the same reasoning used in Chapter III (Methodology) could be applied again to assess these possible metrics impositions on the contractor. As discussed earlier, a certain degree of adjustment in various logistical factors would be needed to accommodate these possible parameter changes, but they would almost certainly end up impacting, to some degree, support costs. Nearly every improvement desired in a logistics support structure would be accompanied by an additional expense. And these extra costs would surely be charged to the end customer.

The case being made here is that all intermediate metrics enforced to the contractor will act as an additional constraint, with a potential negative effect on life support costs, unless the positive effects of adding such metrics to the logistics system outweigh the negative consequences of cost increases, as observed in some unlikely scenarios simulated in this study.

For this reason, the evidences here support that managers should focus only on demanding from contractors the performance targets truly related to the achievement of the fleet's operational mission, like aircraft availability or, ideally, mission readiness (the latter much more difficult to measure and demand from the contractor). When requiring performance parameters unrelated to the final objectives, there is a prospective risk of paying for additional logistical capacity that will be idle.

Another potential problem related to adding unreasonable metrics to a performance-based contract can occur when payments are linked to meeting these performance goals. If the contractor fails to achieve such unnecessary intermediate targets, they may end up receiving less money in return for their services. And if they got less resources to invest in fleet support, they could perform even worse. As a result, their payments may be further reduced, and so on. This type of “death spiral” is encouraged when intermediate metrics are increasingly adopted in performance-based contracts.

## V. Conclusions and Recommendations

### Summary of the Research and Answers to Research Questions

A simulation experiment was planned and successfully executed in this research, with the objective of providing quantitative evidence about the inherent mechanisms existing in a logistics support chain affected by changes in its operating parameters. The main idea was to replicate a possible performance-based contract design definition, in an attempt to show how the imposition of additional performance metrics could represent an additional challenge for contractors and costumers to achieve the desired results for an operational fleet.

In seeking to answer the proposed research questions, it was possible to find indications that life support costs are strongly sensitive to the addition of new metrics to a performance-based contract, as was observed in the simulations when testing logistics responses to changes in turnaround times and repair costs.

In most cases, the expenses to sustain the logistics system became higher when enforcing lower TAT, considering the related increases in repair costs to meet such demand. Nevertheless, it was also found the possibility of obtaining lower sustainment costs when requiring a lower time to get the components back from repair, but the conditions for this to occur are considered unlikely, requiring much faster deliveries with increases of only 5% in unit repair costs.

For the conditions tested, more complex support organizations also performed better when subjected to changes in the mix TAT/repair costs, with slightly lower percentage increases in life support costs. And among all the tested logistics scenarios,

the one with fewer operational bases and depots, and more workshops, it was the one that presented a better combination between lower absolute LSC and response to fluctuations in escalating unit repair costs due to faster delivery obligations.

### **Significance of Research**

There is a vast amount of literature addressing Performance Based Logistics and its correlated theme Performance Based Contracting, but at the same time a lack of quantitative studies within these areas.

On the latter topic, much has been said about its possible benefits and how it can enhance the logistics chain to deliver better results than in the conventional transaction-based approach, but scarce studies report the practical challenges associated with setting performance requirements.

Hence, this research contributes by providing quantitative indications on the intrinsic mechanisms concerned with the contract design definitions, advising logistics managers with measurable evidence regarding the side effects that the imposition of performance metrics can have on life support costs.

More than that, it offers an approach that can be reproduced in future studies that deal with complementary analysis on this subject, or even for leaders who seek to make more enlightened judgments in actual cases.

### **Recommendations for Actions**

The main takeaway identified in this research is that decisions about performance metrics should be extremely cautious, given the inherent jeopardy associated with such additional requirements. Based on the findings reported here, evidence was produced indicating that performance-based contracts should preferentially define only goals more



directly related to the final objective of an aircraft fleet, like system availability or, ideally, mission readiness, which is harder to measure and demand from the contractor because it involves the uncertainty of operational schedule.

If strictly necessary, intermediate metrics must be applied carefully and after a detailed assessment aiming to identify the current operating characteristic of the existing logistical support system, in an effort to eventually requiring, as far as possible, the maintenance of the ruling logistical parameters, avoiding a need for a sharp readjustment of the logistics support structure, thus reducing the possible negative effects of such in-between metrics.

### **Recommendations for Future Research**

Several improvements can be done using this study as a starting point. More specific logistics scenarios could be used, allowing bases to be used as warehouses or enabling lateral support, for example. Base and depot-level maintenance could also be added as possibilities in the logistics support structure.

Different cost families could also be considered, adding depreciation rates, reorder costs, storage and transportation expenses, among others. Hereupon, this research did not consider the possible promising effects of the allowed inventory reduction induced by faster turnaround times, which would act positively by reducing, for instance, depreciation and storage costs.

Also, the use of real data in the analysis would be a great challenge, for the reasons discussed in previous chapters, but it would certainly be an amazing opportunity for complementary research.

A final suggestion would be to expand this analysis to different types of metrics that could be used in performance-based contract, using different experiences from previous contracts. Thus, for example, in an agreement in which the contractor is responsible for carrying out all the maintenances of the aircraft, a metric that imposes a maximum period of time for each type of maintenance could certainly be specified by the procurement team. And this would be another interesting research case, which could be assessed employing the simulation tools used in this study or even another methodology. The risks in such situation would be similar to those faced in this research, but only a dedicated study would be able to identify whether the life support cost inherent in that support organization would be strongly affected by those metric changes or not.

### **Conclusions of Research**

This study was able to provide evidences about the prospective side effects that may arise from unfounded decisions regarding performance metrics when designing a performance-based contract. It became clear by what means a simple change in the logistics system requirements can lead to a significant increase in life support costs, and how this effect can vary depending on the support organization structure.

The rationale discussed in this research can guide administrators to make more informed judgments in the logistics support planning process. The specification of in-between performance parameters may seem interesting and even tempting while negotiating performance-based agreements with contractors, giving the impression of creating a more robust supply chain.

However, managers must keep in mind the potential risks of acquiring additional unused logistics capacity at a high price. In addition, if payments to the contractor are

penalized for not reaching such unnecessary goals, the logistics support may be not only more expensive, but can also be impaired in the medium to long-term, all of which result from a motivation without real need.

Even in hypothetical scenarios where there is a theoretical possibility of reducing life support costs by adopting additional intermediate metrics, there will be some practical infeasibility in getting rid of the eventual extra allocation of inventory that will emerge with the adoption of improved logistics parameters. As a consequence, it is likely that the logistics system will end up with idle capacity, synonymous with inappropriate use of resources.

## Bibliography

- Air Force Magazine. (2019). *2019 USAF Almanac*.
- Bengtsson, M., & Kurdve, M. (2016). Machining Equipment Life Cycle Costing Model with Dynamic Maintenance Cost. *Procedia CIRP*, 48, 102–107.
- Berkowitz D, Gupta JN, Simpson JT, McWilliams JO, Delayne L, Brown BE, Cameron D, S. T. (2003). *Performance based logistics*.
- Bowersox, D. J., & Closs, D. J. (1989). Simulation In Logistics: A Review Of Present Practice And A Look To The Future. *Journal of Business Logistics*, Vol. 10(Issue 1), p133-148.
- Bussche, J. W. van den. (2019). *Dynamic spare part control for performance-based service contracts : a discrete-event simulation study*. University of Twente.
- Camm, F., Blickstein, I., & Venzor, J. (2004). *Recent Large Service Acquisitions in the Department of Defense: Lessons for the Office of the Secretary of Defense*. RAND Corporation.
- Coogan, C. O., & Fellow, C. P. L. (2003). Performance Based Logistics: What It Takes. *The Center for Executive Education, the University of Tennessee, USA*.
- Datta, P. P., & Roy, R. (2013). Incentive issues in performance-based outsourcing contracts in the UK defence industry: A simulation study. *Production Planning and Control*, 24(4–5), 359–374.
- Davis, J., Newman, D., & Kotzian, M. (2016). Performance Based Logistics ... What's Stopping Us? *Defense AT&L: March-April 2016*.
- Doerr, K., Eaton, D. R., & Lewis, I. A. (2004). Characteristics of Good Metrics for Performance-Based Logistics. *2nd Annual Acquisition Research Symposium of the Naval Postgraduate School*, 66–81.
- Gardner, C. P., Ogden, J. A., Kahler, H. M., & Brady, S. (2015). Balancing Incentives and Risks in Performance Based Contracts. *Defense Acquisition Review Journal*, 22(4), 472–506.
- Girth, A. M. (2014). A closer look at contract accountability: Exploring the determinants of sanctions for unsatisfactory contract performance. *Journal of Public Administration Research and Theory*, 24(2), 317–348.
- Glas, A., Hofmann, E., & Eßig, M. (2013). Performance-based logistics: A portfolio for contracting military supply. *International Journal of Physical Distribution and Logistics Management*, 43(2), 97–115.

- Hallin, S. (2015). *Modeling of Life-Limited Spare Units in a Steady-State Scenario*. KTH Royal Institute of Technology.
- Hunter, A., & Ellman, J. (2017). Use of Incentives In Performance Based Logistics Contracting. *Fourteenth Annual Acquisition Research Symposium*.
- Hurkens, K., van der Valk, W., & Wynstra, F. (2006). Total cost of ownership in the services sector: A case study. *Journal of Supply Chain Management*, 42(1), 27–37.
- Karlsson, V. (2015). *A framework for evaluating the effects on Life Support Cost by design and support decisions*. KTH Royal Institute of Technology.
- Kim, S. H., Cohen, M. A., Netessine, S., & Veeraraghavan, S. (2010). Contracting for infrequent restoration and recovery of mission-critical systems. *Management Science*, 56(9), 1551–1567.
- Lindqvist, M., & Lundin, J. (2010). *Spare Part Logistics and Optimization for Wind Turbines-Methods for Cost-Effective Supply and Storage*. Uppsala University.
- Lopes, J. C. O., Scarpel, R., Abrahao, F. T. M., Galar, D., & Ciani, L. (2017). Optimization in performance-based logistics contracts. *4th IEEE International Workshop on Metrology for AeroSpace, MetroAeroSpace 2017 - Proceedings*, 413–418.
- Losey, S. (2018). *Fewer planes are ready to fly: Air Force mission-capable rates decline amid pilot crisis*. Air Force Times. <https://www.airforcetimes.com/news/your-air-force/2018/03/05/fewer-planes-are-ready-to-fly-air-force-mission-capable-rates-decline-amid-pilot-crisis/>
- Nowicki, D., Randall, W. S., & Gorod, A. (2010). A framework for performance based logistics: A system of systems approach. *International Congress on Ultra Modern Telecommunications and Control Systems*, 681–692.
- Randall, W. S., Pohlen, T. L., & Hanna, J. B. (2010). Evolving a Theory of Performance-Based Logistics using insights from Service Dominant Logic. *Journal of Business Logistics*, 31(2), 35–61.
- Rogers, P. (2002). Optimum-seeking simulation in the design and control of manufacturing systems: Experience with optquest for arena. *Winter Simulation Conference Proceedings*, 2, 1142–1150.
- Selviaridis, K., & Norrman, A. (2015). Performance-based contracting for advanced logistics services. *International Journal of Physical Distribution & Logistics Management*, 45(6), 592–617.
- Systecon. (n.d.). *OPUS10 - More than Spare Parts Optimization*. <https://www.systecongroup.com/us/node/23>

- Tysseland, B. E. (2009). Spare parts optimization process and results: Opus10 cases in the Norwegian Defence. *International Journal of Physical Distribution & Logistics Management*, 39(1), 8–27.
- U.S. Department of Defense. (2016). *PBL Guidebook: A Guide to Developing Performance-Based Arrangements*. U.S. Department of Defense.
- Wååk, O., & Sturgess, P. (2000). Evaluating cost effectiveness and risk of third party support. *Defence Logistics Support Conference, December*.
- Wijk, O., & Andersson, P. (2012). Simulation as Support for PBL Contract Design. In U. Kumar, R. Karim, & A. Parida (Eds.), *Proceedings of the 2nd international workshop and congress on eMaintenance* (pp. 37–42). Luleå University of Technology.
- Woodward, D. G. (1997). Life cycle costing - Theory, information acquisition and application. *International Journal of Project Management*, 15(6), 335–344.
- Wu, M. C., & Hsu, Y. K. (2008). Design of BOM configuration for reducing spare parts logistic costs. *Expert Systems with Applications*, 34(4), 2417–2423.

<b>REPORT DOCUMENTATION PAGE</b>			<i>Form Approved</i> <i>OMB No. 0704-0188</i>		
Public reporting burden for this collection of information is estimated to average 1 hour per response, including the time for reviewing instructions, searching existing data sources, gathering and maintaining the data needed, and completing and reviewing this collection of information. Send comments regarding this burden estimate or any other aspect of this collection of information, including suggestions for reducing this burden to Department of Defense, Washington Headquarters Services, Directorate for Information Operations and Reports (0704-0188), 1215 Jefferson Davis Highway, Suite 1204, Arlington, VA 22202-4302. Respondents should be aware that notwithstanding any other provision of law, no person shall be subject to any penalty for failing to comply with a collection of information if it does not display a currently valid OMB control number. <b>PLEASE DO NOT RETURN YOUR FORM TO THE ABOVE ADDRESS.</b>					
<b>1. REPORT DATE (DD-MM-YYYY)</b> 23-03-2020		<b>2. REPORT TYPE</b> Master's Thesis		<b>3. DATES COVERED (From - To)</b> August 2018 – March 2020	
<b>4. TITLE AND SUBTITLE</b>  Inherent Jeopardy of Performance Based Contracting Metrics: a Simulation Experiment			<b>5a. CONTRACT NUMBER</b>		
			<b>5b. GRANT NUMBER</b>		
			<b>5c. PROGRAM ELEMENT NUMBER</b>		
<b>6. AUTHOR(S)</b>  Daniel Cherobini, Captain, Brazilian Air Force			<b>5d. PROJECT NUMBER</b>		
			<b>5e. TASK NUMBER</b>		
			<b>5f. WORK UNIT NUMBER</b>		
<b>7. PERFORMING ORGANIZATION NAME(S) AND ADDRESS(ES)</b> Air Force Institute of Technology Graduate School of Engineering and Management (AFIT/EN) 2950 Hobson Way, Building 640 WPAFB OH 45433-7765			<b>8. PERFORMING ORGANIZATION REPORT</b>  AFIT-ENS-MS-20-M-139		
<b>9. SPONSORING / MONITORING AGENCY NAME(S) AND ADDRESS(ES)</b> Agency: Brazilian Air Force Institute of Logistics (ILA) Address: Av. Monteiro Lobato, 4455, Guarulhos – SP, Brazil, 07184			<b>10. SPONSOR/MONITOR'S ACRONYM(S)</b> ILA		
			<b>11. SPONSOR/MONITOR'S REPORT NUMBER(S)</b>		
<b>12. DISTRIBUTION / AVAILABILITY STATEMENT</b> DISTRIBUTION STATEMENT A: APPROVED FOR PUBLIC RELEASE; DISTRIBUTION UNLIMITED					
<b>13. SUPPLEMENTARY NOTES</b> This material is declared a work of the U.S. Government and is not subject to copyright protection in the U.S.					
<b>14. ABSTRACT</b> There is a growing trend across the world to adopt Performance Based Contracting strategies to support logistics systems. Using these policies, contract payments are strongly related to the performance achieved compared to prespecified metrics. However, managers are not always confident on what are the most suitable performance goals to use in these agreements. As a consequence, contractors struggle to deliver the desired performance results, while aircraft fleets experience an increase in support costs. And when the results are inadequate, leaders are tempted to impose even more performance targets to contractors, willing to exercise more control over the support organization. In this research, simulation is used to provide quantitative evidence of how sensitive life support costs are to adding metrics to a performance-based contract, with a focus on changes in turnaround times and repair costs, for different logistical configurations. The study acknowledges the potential risk of adding intermediate metrics to these contracts, which possibly will only raise life support costs without a positive effect on the main objectives of a fleet: mission readiness or simply availability. Ultimate negative effects on contractors are also discussed and recommendations are provided to managers on how they could design more successful performance-based contracts.					
<b>15. SUBJECT TERMS</b> Performance Based Contracting, Metrics, Performance Goals, Life Support Costs, Simulation					
<b>16. SECURITY CLASSIFICATION OF:</b>			<b>17. LIMITATION OF ABSTRACT</b>  UU	<b>18. NUMBER OF PAGES</b>  78	<b>19a. NAME OF RESPONSIBLE PERSON</b> Dr. Seong-Jong Joo (ENS)
<b>a. REPORT</b> U	<b>b. ABSTRACT</b> U	<b>c. THIS PAGE</b> U			<b>19b. PHONE NUMBER (include area code)</b> (719) 246-4686 seong-jong.joo@afit.edu
<b>REPORT DOCUMENTATION PAGE</b>			<i>Form Approved</i> <i>OMB No. 0704-0188</i>		